

Operating Instructions

SIP Phone



KX-HDV230

Model No.

KX-HDV130

KX-HDV230

Thank you for purchasing this Panasonic product.

Please read this manual carefully before using this product and save this manual for future use.

Note

- In this manual, the suffix of each model number is omitted unless necessary.
- The illustrations such as some keys may differ from the appearance of the actual product.
- Certain products and features described in this document may not be available in your country or area. Contact your phone system dealer/service provider.
- The contents and design of the software are subject to change without notice.

Introduction

This manual describes information about the installation and operation of KX-HDV130 / KX-HDV230.

Related Documentation

- **Quick Start Guide**
Describes basic information about the installation and safety precautions to prevent personal injury and/or damage to property.
- **Administrator Guide**
Describes detailed information about the configuration and management of this unit.

Manuals and supporting information are provided on the Panasonic Web site at:
<https://panasonic.net/cns/pcc/support/sipphone/>

For Future Reference

Record the information in the space below for future reference.

Note

- The serial number and MAC address of this product may be found on the label affixed to the bottom of the unit. You should note the serial number and MAC address of this unit in the space provided and retain this manual as a permanent record of your purchase to aid in identification in the event of theft.

MODEL NO.	KX-HDV130 / KX-HDV230
SERIAL NO.	
MAC ADDRESS	
DATE OF PURCHASE	
NAME OF DEALER	
DEALER'S ADDRESS	
DEALER'S TEL. NO.	

Table of Contents

1	Important Information	5
1.1	Data Security	6
1.2	Disposal of Old Equipment and Batteries	6
1.3	Regional Information	7
1.3.1	For Users in European Countries	7
1.3.2	For Users in the United Kingdom	7
1.3.3	For Users in Australia	7
1.3.4	For Users in Australia and the United Kingdom	7
1.3.5	For Users in New Zealand	7
1.3.6	For Users in the United States	8
1.3.7	For Users in Canada	9
1.4	For Best Performance	11
2	Before Operating the Telephones	13
2.1	Accessory Information	14
2.2	Installation and Setup	16
2.2.1	Attaching the Stand	16
2.2.2	Adjusting the Stand Position	17
2.2.3	Removing the Stand	17
2.2.4	Attaching the Optional KX-HDV20 to the Unit (KX-HDV230 only)	18
2.2.5	Connections (including optional KX-HDV20)	19
2.2.6	Wall Mounting	22
2.2.7	Hooking the Handset	26
2.3	Location of Controls	27
2.4	The Display and Icons	36
2.4.1	Main Display	36
2.4.2	Sub Display (Self-labeling LCD) (KX-HDV230 only)	38
2.5	Main Menu	40
2.6	Keys	41
2.6.1	Soft Keys	41
2.7	Phonebook	43
2.8	Basic Operations	44
2.8.1	Going off- and on-hook	44
2.8.2	Adjusting the Volume	45
2.8.3	Entering Characters	45
2.8.4	Using the Incoming/Outgoing Call Log	46
3	Feature Operations	47
3.1	Making Calls	48
3.1.1	Basic Calling	48
3.1.2	Easy Dialing	48
3.1.3	Making a Multicast Voice Paging call	50
3.2	Receiving Calls	51
3.2.1	Answering Calls	51
3.3	Using Hands-free Mode	53
3.4	During a Conversation	54
3.4.1	Transferring a Call (Call Transfer)	54
3.4.2	Holding a Call	54
3.4.3	Holding in a System Parking Zone (Call Park)	55
3.4.4	Talking to Two Parties Alternately (Call Splitting)	56
3.4.5	Making a Three-party Conference	56
3.4.6	Muting the Microphone or the Handset	57

3.4.7	Using Call Waiting	57
3.4.8	Using Off-hook Monitor	58
3.4.9	Using Training Mode (KX-HDV230 only)	58
3.5	Before Leaving Your Desk	59
3.5.1	Setting Call Forwarding and Do Not Disturb	59
3.6	Using the Phonebook	60
3.6.1	Storing an Item in the Local Phonebook	60
3.6.2	Editing a stored item in the Local Phonebook	61
3.6.3	Deleting a Stored Item in the Local Phonebook	62
3.6.4	Searching for an Item in the Local Phonebook	63
3.6.5	Locking/Unlocking the Local Phonebook	64
3.6.6	Searching for an Item in the Remote Phonebook	65
3.7	Checking the Line Status	66
3.8	Listening to Voice Mail Messages	68
4	Customizing the Telephone	69
4.1	Setting the LCD Display	70
4.2	Setting the Password	71
4.3	Editing Soft Keys	72
4.4	Using Hot Keys	73
4.5	Function Keys (Program Keys and DSS Keys ¹)	75
4.5.1	Changing the Function Keys	75
4.5.2	The Types of Function Keys	75
4.6	Using the Anonymous Call Features	79
4.7	Barring Incoming Calls (Caller ID ¹ service users only)	80
4.8	Setting ECO Mode	82
4.9	Changing the Basic Setting	83
4.9.1	Basic Settings Menu Layout	83
4.10	Changing the System Settings	89
4.10.1	System Settings Menu Layout	89
4.11	Web User Interface Programming	94
4.12	Updating the Software	94
5	Appendix	95
5.1	Character Mode Table	96
5.2	Character Table for Administrator Password	101
5.3	Specifications	102
5.4	Troubleshooting	105
5.5	Error Messages	108
5.6	Revision History	109
5.7	Wall mounting template	110
5.7.1	KX-HDV130	110
5.7.2	KX-HDV230, optionally with 1 attached KX-HDV20	111
5.7.3	For mounting 2 or more KX-HDV20 units (KX-HDV230 only)	112

Section 1

Important Information

This section provides important information intended to prevent personal injury and property damage.

1.1 Data Security

We cannot be responsible for damages resulting from the misuse of this product.

- Keep a copy of all important data (such as the phonebook list) in case the machine malfunctions and data cannot be recovered.
- This product can store your private/confidential information. To protect your privacy/confidentiality, we recommend that you erase the information such as the phonebook or call log from the memory before you dispose of, transfer or return the product, or have the product repaired.
- To avoid unauthorized access to this product:
 - Keep the password secret.
 - Change the default password.
 - Set a password that is random and cannot be easily guessed.
 - Change the password regularly.
- Security settings, such as passwords, cannot be undone at Panasonic service centers. Take measures to prevent passwords from being lost or forgotten.
- If a password is forgotten, initialize the unit and configure the settings again. For details, consult your administrator or dealer.
- It is recommended that you lock the phonebook to prevent stored information from being leaked.

1.2 Disposal of Old Equipment and Batteries

Only for European Union and countries with recycling systems



These symbols on the products, packaging, and/or accompanying documents mean that used electrical and electronic products and batteries must not be mixed with general household waste.

For proper treatment, recovery and recycling of old products and batteries, please take them to applicable collection points in accordance with your national legislation.

By disposing of them correctly, you will help to save valuable resources and prevent any potential negative effects on human health and the environment.

For more information about collection and recycling, please contact your local municipality. Penalties may be applicable for incorrect disposal of this waste, in accordance with national legislation.



Note for the battery symbol (bottom symbol)

This symbol might be used in combination with a chemical symbol. In this case it complies with the requirement set by the Directive for the chemical involved.

1.3 Regional Information

1.3.1 For Users in European Countries

The following declaration is applicable to KX-HDV130NE / KX-HDV130X / KX-HDV230NE / KX-HDV230X only.

For information of Compliance with EU relevant Regulatory Directives,
Contact to Authorized Representative:
Panasonic Testing Center
Panasonic Marketing Europe GmbH
Winsbergring 15, 22525 Hamburg, Germany

Ecodesign information

Ecodesign information under EU Regulation (EC) No.1275/2008 amended by (EU) Regulation No.801/2013.

=====
Please visit here: <http://www.ptc.panasonic.eu>
click [Downloads]

→ Energy related products information (Public)

=====
Power consumption in networked standby and guidance are mentioned in the web site above.

1.3.2 For Users in the United Kingdom

- This unit is designed to be installed under controlled conditions of ambient temperature and a relative humidity.
- Avoid installing the unit in damp or humid environments, such as bathrooms or swimming pools.
- 999 and 112 can be dialed on the product after accessing the outside line for the purpose of making outgoing calls to the BT emergency (999) and (112) services. The method for accessing an outside line differs depending on the SIP server. For details, confirm the features of the SIP server.

1.3.3 For Users in Australia

WARNING

- Please ensure that a separate telephone, not dependent on local power, is available for emergency use.
- This equipment will be inoperable when mains power fails.
- No "000" or other calls can be made from this device during a mains power failure.

1.3.4 For Users in Australia and the United Kingdom

- This unit is capable of being used in conjunction with hearing aids fitted with inductive coil pick-ups. The handset should be held as for normal conversation. For operation, the hearing aid should be set to its "T" position or as directed in the operating instructions for the hearing aid.
- This unit is designed to aid the visually handicapped to locate dial keys and buttons.



1.3.5 For Users in New Zealand

This equipment shall not be set to make automatic calls to the Telecom '111' Emergency Service.

PTC General Warning

The grant of a Telepermit for any item of terminal equipment indicates only that Telecom has accepted that the item complies with minimum conditions for connection to its network. It indicates no endorsement of the product by Telecom, nor does it provide any sort of warranty. Above all, it provides no assurance that any item will work correctly in all respects with another item of Telepermitted equipment of a different make or model, nor does it imply that any product is compatible with all of Telecom's network services.

The Use of IP Networks through the PSTN

Internet Protocol (IP) by its nature introduces delay into speech signals as each data packet is formulated and addressed. Telecom Access Standards recommends that suppliers, designers and installers using this technology for calls to or from the PSTN refer to ITU E Model requirements in the design of their networks. The overall aim is to minimize delay, distortion and other transmission impairments, particularly for those calls involving cellular and international networks, which already suffer extensive delay.

Echo cancellation

Echo cancelers are not normally required in the Telecom PSTN because geographic delays are acceptable where CPE return loss is maintained within Telepermit limits. However, those private networks making use of Voice over IP technology are required to provide echo cancellation for all voice calls. The combined effect of audio/VoIP conversion delay and IP routing delay can cause the echo cancellation time of ≥ 64 ms to be required.

Important Notice

- Under power failure conditions this appliance may not operate. Please ensure that a separate telephone, not dependent on local power, is available for emergency use.
- No "111" or other calls can be made from this device during a mains power failure.

1.3.6 For Users in the United States

Note

- This equipment has been tested and found to comply with the limits for a Class B digital device, pursuant to Part 15 of the FCC Rules. These limits are designed to provide reasonable protection against harmful interference in a residential installation. This equipment generates, uses, and can radiate radio frequency energy and, if not installed and used in accordance with the instructions, may cause harmful interference to radio communications. However, there is no guarantee that interference will not occur in a particular installation. If this equipment does cause harmful interference to radio or television reception, which can be determined by turning the equipment off and on, the user is encouraged to try to correct the interference by one or more of the following measures:
 - Reorient or relocate the receiving antenna.
 - Increase the separation between the equipment and receiver.
 - Connect the equipment to an outlet on a circuit different from that to which the receiver is connected.
 - Consult the dealer or an experienced radio/TV technician for help.

This device complies with Part 15 of the FCC Rules. Operation is subject to the following two conditions:

- (1) this device may not cause harmful interference, and (2) this device must accept any interference received, including interference that may cause undesired operation.

WHEN PROGRAMMING EMERGENCY NUMBERS AND/OR MAKING TEST CALLS TO EMERGENCY NUMBERS:

1. Remain on the line and briefly explain to the dispatcher the reason for the call before hanging up.

2. Perform such activities during off-peak hours, such as early morning or late evening.

CAUTION

Any changes or modifications not expressly approved by the party responsible for compliance could void the user's authority to operate this product.

Hearing Aid Compatibility

This telephone provides magnetic coupling for hearing aids as defined by the FCC in 47 CFR Section 68.316. Use only handsets or other acoustic devices with this equipment that are compliant with the hearing aid compatibility requirements of FCC Part 68.

When you hold the phone to your ear, noise might be heard in your Hearing Aid. Some Hearing Aids are not adequately shielded from external RF (radio frequency) energy. If noise occurs, use an optional headset accessory or the speakerphone option (if applicable) when using this phone. Consult your audiologist or Hearing Aid manufacturer about the availability of Hearing Aids which provide adequate shielding to RF energy commonly emitted by digital devices.

Compliance with TIA-1083 standard:



Telephone handsets identified with this logo have reduced noise and interference when used with T-Coil equipped hearing aids and cochlear implants.

Responsible Party

Panasonic Corporation of North America
Two Riverfront Plaza, Newark, New Jersey 07102-5490

Technical Support

Panasonic Corporation of North America
Two Riverfront Plaza, Newark, New Jersey 07102-5490
Telephone: 1 (800) 528-6747 Option 1

1.3.7 For Users in Canada

Industry Canada Notices and Other Information

This product meets the applicable Innovation, Science and Economic Development Canada technical specifications.

Notice

- This Class B digital apparatus complies with Canadian ICES-003.

CAUTION

- Any changes or modifications not expressly approved by the party responsible for compliance could void the user's authority to operate this product.

Compliance with TIA-1083 standard:



Telephone handsets identified with this logo have reduced noise and interference when used with T-Coil equipped hearing aids and cochlear implants.

1.4 For Best Performance

Environment

- Keep the product away from heating appliances and devices that generate electrical noise, such as fluorescent lamps, motors and televisions. These noise sources can interfere with the performance of the product.
- Do not place the product in rooms where the temperature is less than 0 °C (32 °F) or greater than 40 °C (104 °F).
- Allow 10 cm (4 in) clearance around the product for proper ventilation.
- Avoid environments with excessive smoke, dust, moisture, mechanical vibration, shock, or direct sunlight.
- The apparatus is designed to be installed and operated under controlled conditions of ambient temperature and a relative humidity.

Routine Care

- Unplug the AC adaptor from the AC outlet and disconnect the Ethernet cable before cleaning.
- Wipe the product with a soft cloth.
- Do not clean the product with abrasive powder or with chemical agents such as benzine or thinner.
- Do not use liquid cleaners or aerosol cleaners.

Placement

- Do not place heavy objects on top of the product.
- Care should be taken so that objects do not fall onto, and liquids are not spilled into the product.

Optional Equipment (KX-HDV230 only)

- A KX-HDV20 (20 Key Expansion Module) can be used with the product.
- The KX-HDV20 can be used only when the product receives power from the optional AC adaptor; it cannot be used when the product receives power via Power-over-Ethernet (PoE).
- Up to 5 KX-HDV20 units can be connected to the product.
To mount a second KX-HDV20 unit or more, mount each in turn, unattached to the main unit.

1.4 For Best Performance

Section 2



Before Operating the Telephones

This section shows you the basic information for your telephone.

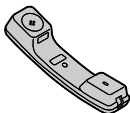

2.1 Accessory Information

Included Accessories

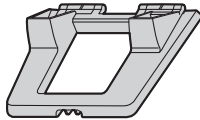
KX-HDV130

Handset: 1 	Handset Cord: 1 	Stand: 1 
---	--	---

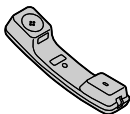
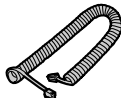
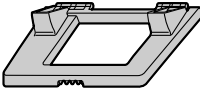
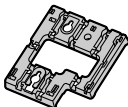
KX-HDV230

Handset: 1 	Handset Cord: 1 	Stand: 1 
Wall Mounting Adaptor: 1 	Screw for wall mounting adaptor: 1 	Screws for wall mounting: 2 

Optional Accessories

KX-HDV130

Model	AC Adaptor ^{*1}	Wall mount kit
KX-HDV130	KX-A423 (PQLV219)	KX-A440
KX-HDV130C		
KX-HDV130NE	KX-A423CE (PQLV219CE)	KX-A440X
KX-HDV130RU		
KX-HDV130X	KX-A423AG (PQLV219AG) / KX-A423AL (PQLV219AL) / KX-A423BR (PQLV219BR) / KX-A423CE (PQLV219CE) / KX-A423E (PQLV219E) / KX-A423X (PQLV219)	
KX-HDV130SX	KX-A423SX (PQLV219SX)	KX-A440SX

^{*1} • To order an optional AC adaptor, please order using the "KX-A423xx" model number. For details about which AC adaptor model number you should order, consult your dealer.





• This unit complies with the IEEE 802.3af Power-over-Ethernet (PoE) standard. If PoE is available on your network, this unit can receive the necessary power from the network through the Ethernet cable. In this case, no AC adaptor is needed. However, if PoE is not available, you will need to connect an AC adaptor to the unit.

KX-HDV230

Model	AC Adaptor ^{*1}	20 Key Expansion Module
KX-HDV230	KX-A422 (PNLV228) / KX-A424 (PNLV6508)	KX-HDV20
KX-HDV230C		
KX-HDV230NE	KX-A422CE (PNLV228) / KX-A424CE (PNLV6508)	KX-HDV20NE
KX-HDV230RU	KX-A424CE (PNLV6508)	KX-HDV20RU
KX-HDV230X	KX-A422X (PNLV228) / KX-A424X (PNLV6508) / KX-A422AL (PNLV228) / KX-A424AL (PNLV6508) / KX-A422CE (PNLV228) / KX-A424CE (PNLV6508) / KX-A422UK (PNLV228) / KX-A424E (PNLV6508) / KX-A424AG (PNLV6508) / KX-A424TW (PNLV6508) / KX-A424BR (PNLV6508)	KX-HDV20X
KX-HDV230SX	KX-A424SX (PNLV6508)	KX-HDV20SX

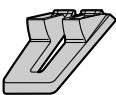
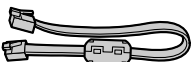
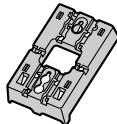
- ^{*1}
- To order an optional AC adaptor, please order using the "KX-A422xx/KX-A424xx" model number. For details about which AC adaptor model number you should order, consult your dealer.
 - This unit complies with the IEEE 802.3af Power-over-Ethernet (PoE) standard. If PoE is available on your network, this unit can receive the necessary power from the network through the Ethernet cable. In this case, no AC adaptor is needed. However, if PoE is not available, you will need to connect an AC adaptor to the unit.

KX-HDV20 Included Accessories (for KX-HDV230 only)

Stand: 1 	Connection cable: 1 	Wall mounting adaptor: 1 
Screw for wall mounting adaptor: 1 	Screws for wall mounting: 2 	Screw for attaching the KX-HDV20 to the unit: 1 

Note

- For users in the United States only**
 - To order accessories, call toll-free 1-800-332-5368.

2.2 Installation and Setup

Note

- Panasonic assumes no responsibility for injuries or property damage resulting from failures arising out of improper installation or operation inconsistent with this documentation.

WARNING

- To reduce the risk of fire or electric shock, do not overload AC outlets and extension cords.
- Completely insert the AC adaptor/power plug into the AC outlet. Failure to do so may cause electric shock and/or excessive heat resulting in a fire.
- Regularly remove any dust, etc. from the AC adaptor/power plug by pulling it from the power outlet, then wiping with a dry cloth. Accumulated dust may cause an insulation defect from moisture, etc. resulting in a fire.

2.2.1 Attaching the Stand

Attach the stand to the desk phone.

1. Insert the stand into the slots located in the unit.
2. Gently rotate the stand in the direction indicated until it is fixed.

KX-HDV130

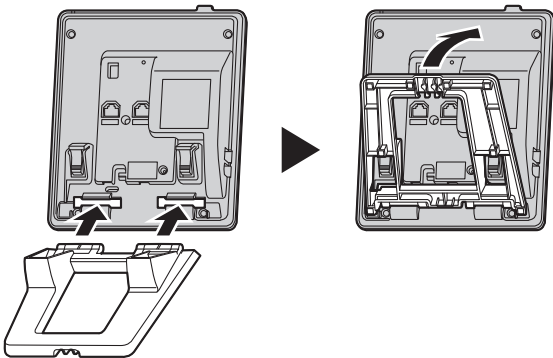

KX-HDV230

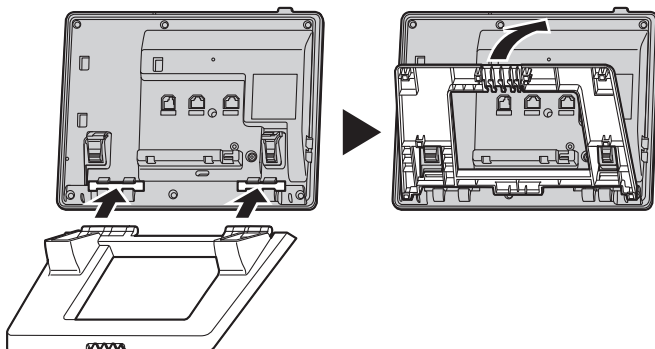

KX-HDV20

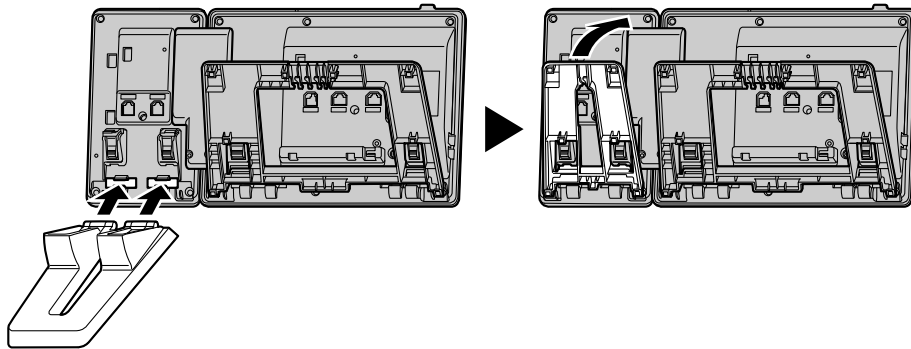

2.2.2 Adjusting the Stand Position

Push the PUSH marks in the direction indicated, with both hands, and tilt and slide the stand until it becomes fixed in the desired position.

- Lowering the stand
EXAMPLE: KX-HDV230

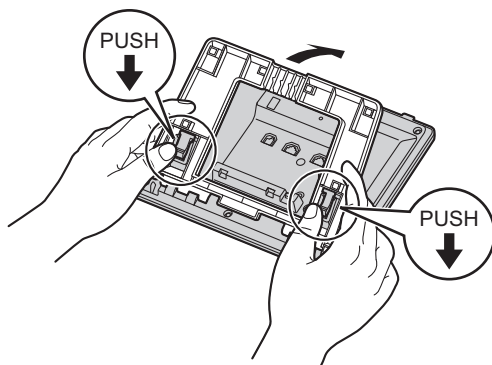

- Raising the stand
EXAMPLE: KX-HDV230

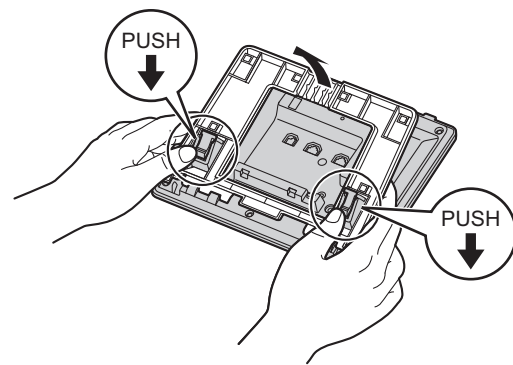

2.2.3 Removing the Stand

Tilt the stand in the direction indicated while pushing the PUSH marks with both hands.

EXAMPLE: KX-HDV230

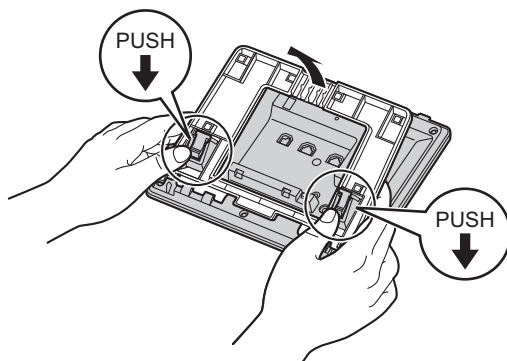

2.2.4 Attaching the Optional KX-HDV20 to the Unit (KX-HDV230 only)

The optional KX-HDV20 has 20 DSS keys, and it adds 40 function keys (20 keys × 2 pages) to the unit. These keys can be used to seize a line to make or receive a call or to perform a feature that has been assigned to the key.

1. Remove the stand from both the KX-HDV230 and KX-HDV20.
2. Insert the tabs of the KX-HDV20 into the designated openings in the base, and then slide the KX-HDV20 in the direction of the arrow.
3. Fasten the KX-HDV20 to the unit with the included screw.

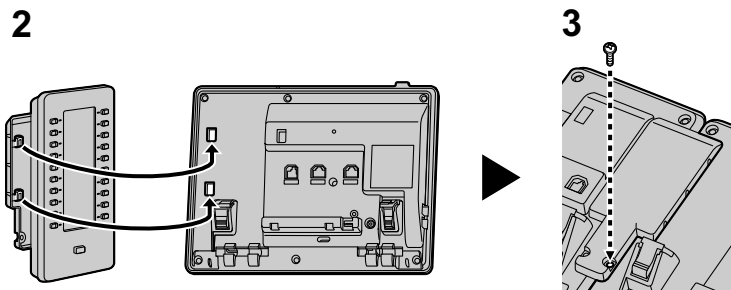

4. Attach the stand to both the KX-HDV230 and the KX-HDV20. See "2.2.1 Attaching the Stand". Or, if the unit will be mounted on a wall, perform wall mounting.
5. Connect the KX-HDV20 to the unit with the included cable.
6. Turn on the KX-HDV230.

Note

- Up to 5 KX-HDV20 units can be connected to the product.

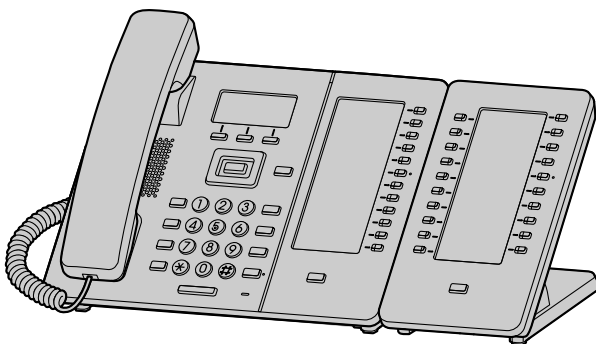

2.2.5 Connections (including optional KX-HDV20)

Connect the Ethernet cable, the Handset Cord and the AC adaptor (option) to the unit.

Notice

- The KX-HDV20 can be used only when the product receives power from the optional AC adaptor; it cannot be used when the product receives power via Power-over-Ethernet (PoE).

Note

- KX-HDV20 can be used with KX-HDV230.

KX-HDV130

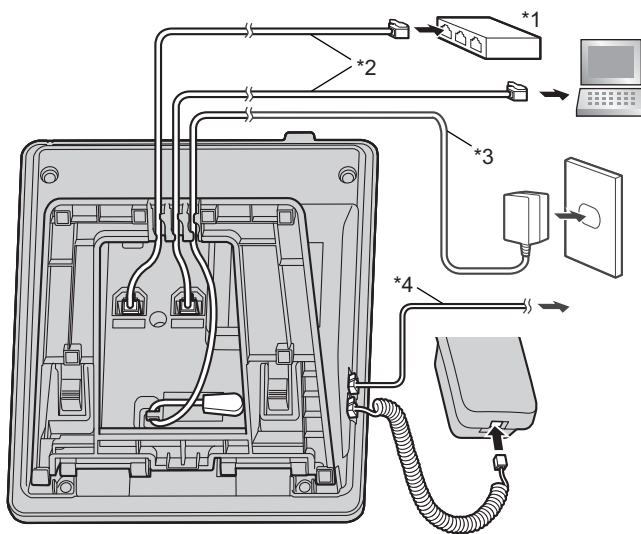

2.2.5 Connections (including optional KX-HDV20)

KX-HDV230 / KX-HDV20

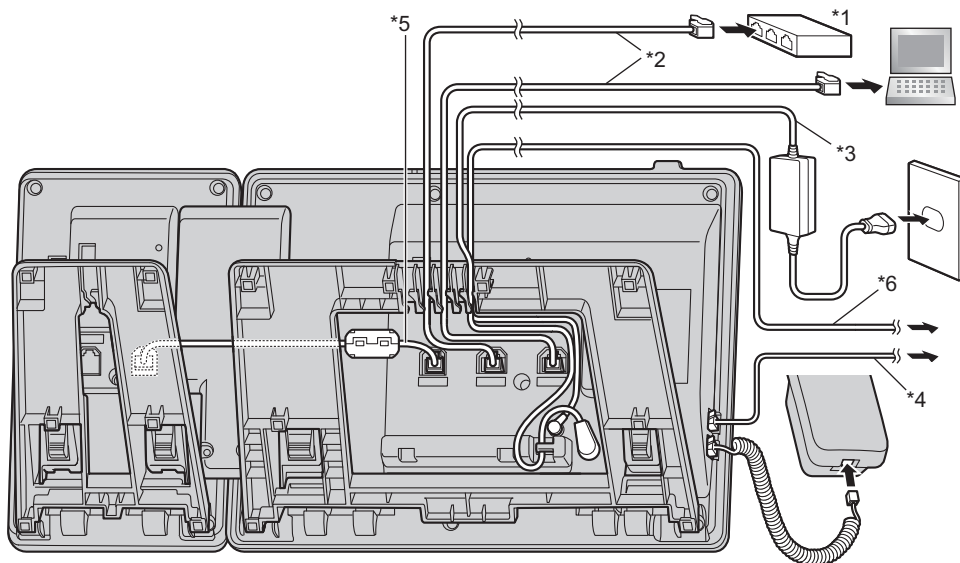

- *1 PoE HUB
- *2 LAN cable
- *3 Optional AC adaptor
- *4 Optional headset
For up-to-date information about headsets that have been tested with this unit, refer to the following web sites:
<https://panasonic.net/cns/pcc/support/sipphone/>
- *5 Connection cable
Connect the connection cable as shown in the illustration.
- *6 Optional EHS headset
For up-to-date information about EHS headsets that have been tested with this unit, refer to the following web site:
<https://panasonic.net/cns/pcc/support/sipphone/>

Note

- The initial setting for the IP address is "DHCP–Auto". For information about your network environment, contact your administrator.

When selecting Ethernet cables (not included)

- Use flexible cables without jack covers. Do not use cables with a hard coating that may tear or crack when bent. To prevent damage to the cables, use cables that do not protrude from the bottom of the base.
- Connect the cables as shown in the following illustration.

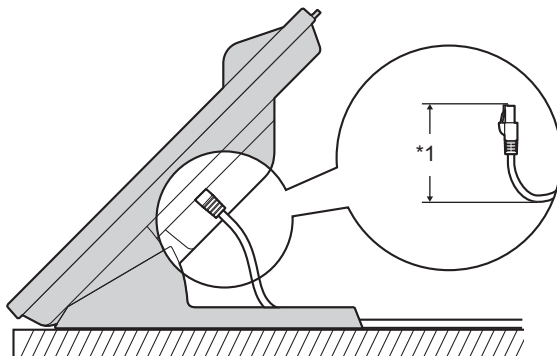

*1 60 mm (2 3/8 in) or less

Use a straight CAT 5e (or higher) Ethernet cable (not included) that is 6.5 mm (1/4 in) in diameter or less.

When connecting to a switching hub

If PoE is available, an AC adaptor is not needed.

If you are using a PoE hub, the number of devices that you can connect simultaneously is limited by the amount of power supplied by the hub.

KX-HDV130: This unit complies with the PoE Class 1 standard.

KX-HDV230: This unit complies with the PoE Class 2 standard.

When connecting a PC

The PC port does not support PoE for connected devices.

When connecting cables and the AC adaptor

Pass the Ethernet cable and the AC adaptor cord under the stand.

2.2.6 Wall Mounting

The KX-HDV230 and up to 5 optional KX-HDV20 units can be mounted on a wall.

Notice

- When inserting screws, avoid pipes and electrical cables, etc., that may be present/buried.
- The screw heads should not be flush to the wall.

Note

- Make sure that the wall and the fixing method are strong enough to support the weight of the unit.
 - You can find a wall mounting template at the end of this manual.
 - Certain types of wall may require plugs to be anchored in the wall before the screws are inserted.
1. Insert the tabs of the wall mounting adaptor into the designated openings in the base, and then slide the wall mounting adaptor in the direction of the arrow until it clicks.

KX-HDV130

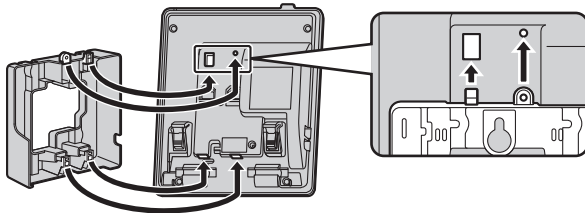

KX-HDV230

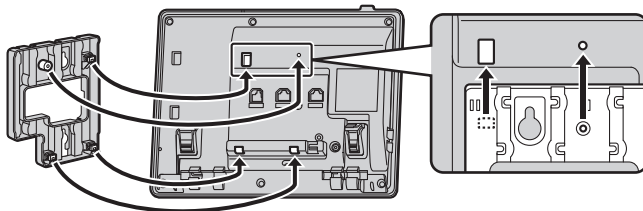

KX-HDV230 with optional KX-HDV20

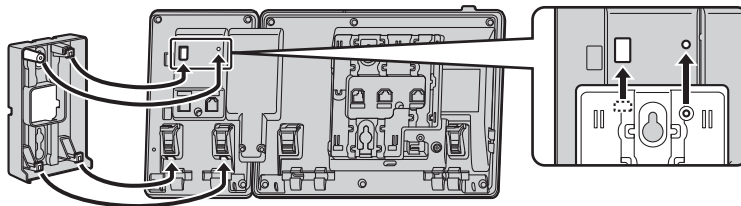

For 2nd to 5th KX-HDV20

Remove the screw from the DSS cover of the KX-HDV20, and then slide the cover up to remove it.

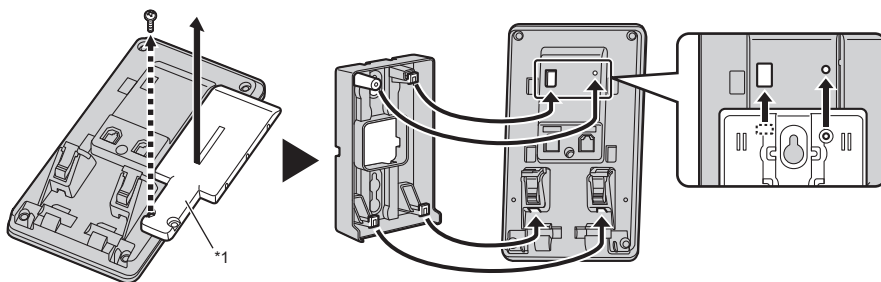

*1 DSS cover

2. Fasten the wall mounting adaptor to the base with the small screw.
(Recommended torque: 0.4 N·m [4.08 kgf·cm / 3.54 lbf·in] to 0.6 N·m [6.12 kgf·cm / 5.31 lbf·in])
3. Connect the AC adaptor, handset cord, Ethernet cables, and connection cable as necessary.
4. Drive the large screws into the wall either 83 mm (3 1/4 in) or 100 mm (3 15/16 in) apart, and mount the unit on the wall.

KX-HDV130

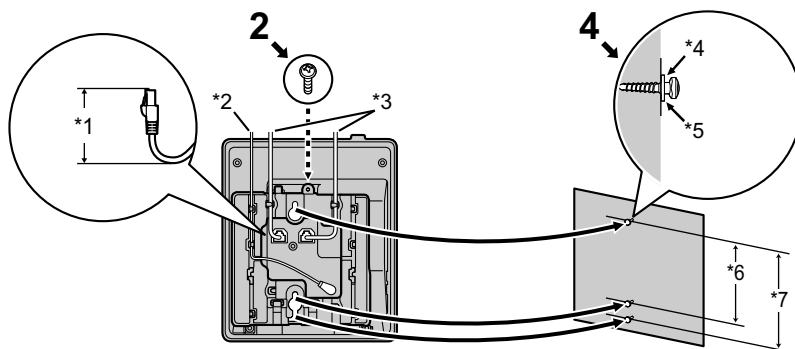

- *1 40 mm (1 37/64 in) or less
- *2 AC adaptor
- *3 Ethernet cables
- *4 Washer
- *5 Drive the screw to this point.
- *6 83 mm (3 1/4 in)
- *7 100 mm (3 15/16 in)

2.2.6 Wall Mounting

KX-HDV230

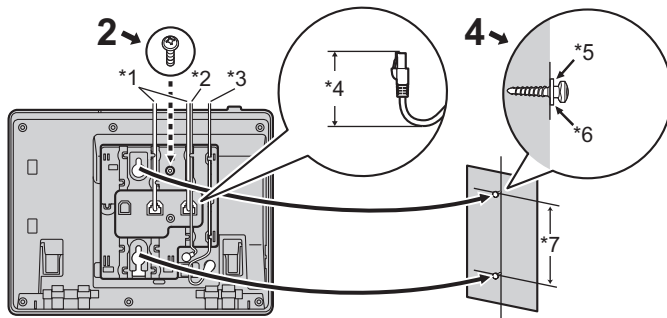

KX-HDV230 with optional KX-HDV20

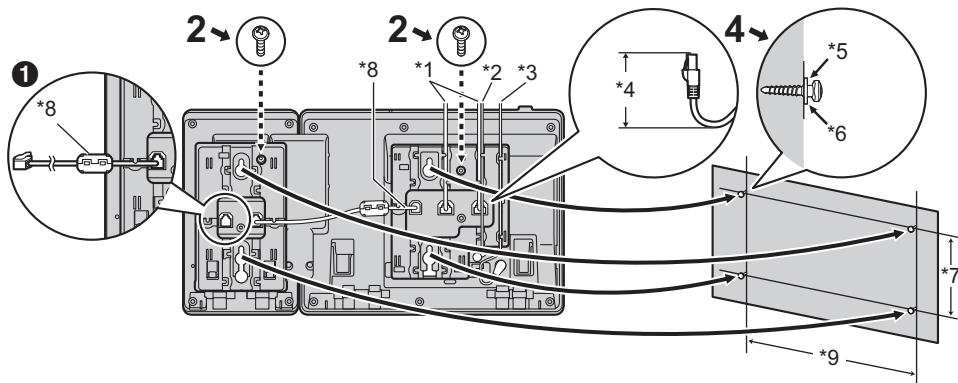

- 1 If you will mount additional KX-HDV20 units, connect the connection cable for the next unit to the unit you are attaching.

For 2nd to 5th KX-HDV20

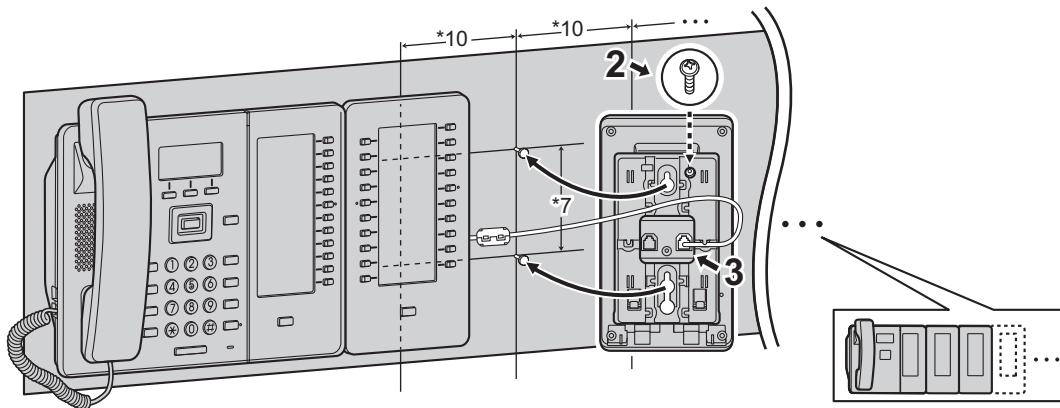

- *1 Ethernet cables
- *2 EHS headset cable
- *3 AC adaptor
- *4 40 mm (1 37/64 in) or less
- *5 Washer
- *6 Drive the screw to this point.
- *7 83 mm (3 1/4 in) or 100 mm (3 15/16 in)
- *8 Connection cable
Connect the connection cable as shown in the illustration.
- *9 179 mm (7 1/16 in)
- *10 111 mm (4 3/8 in)

2.2.7 Hooking the Handset

To Hook the Handset during a Conversation

1. Hook the handset over the top edge of the unit.

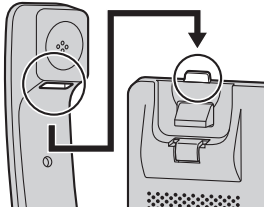

To Lock the Handset Hook when the Unit is Wall Mounted

1. Remove the handset hook from the slot.
2. Turn it up-side-down.
3. Slide the handset hook back into the slot until it locks.
 - Handset is safely hooked when it is in the cradle.

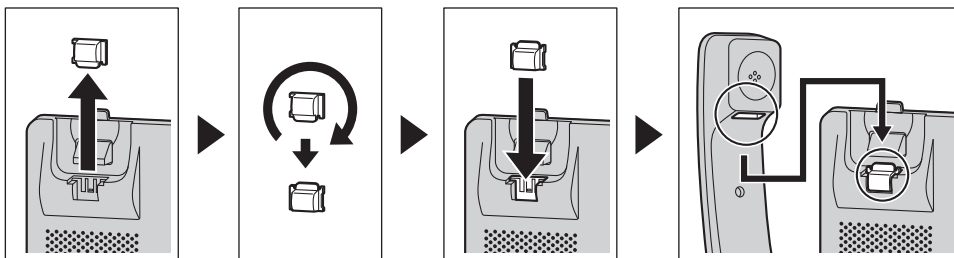

2.3 Location of Controls

KX-HDV130NE

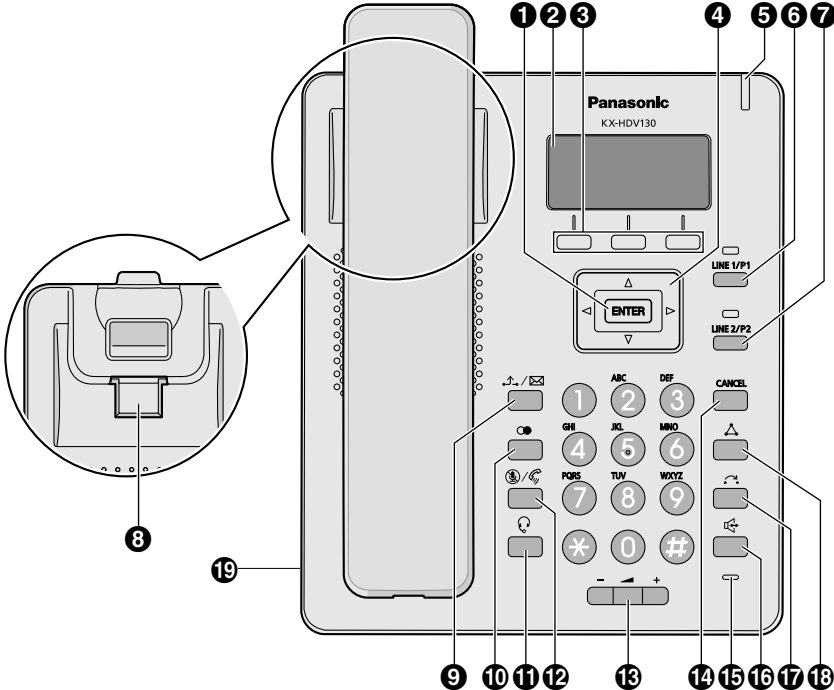

KX-HDV130X / KX-HDV130SX

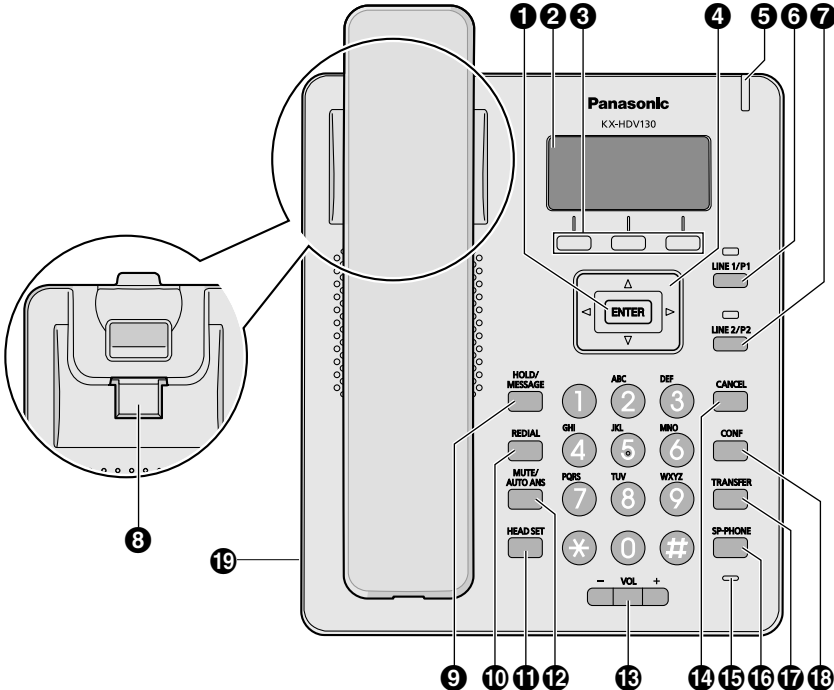

KX-HDV130RU

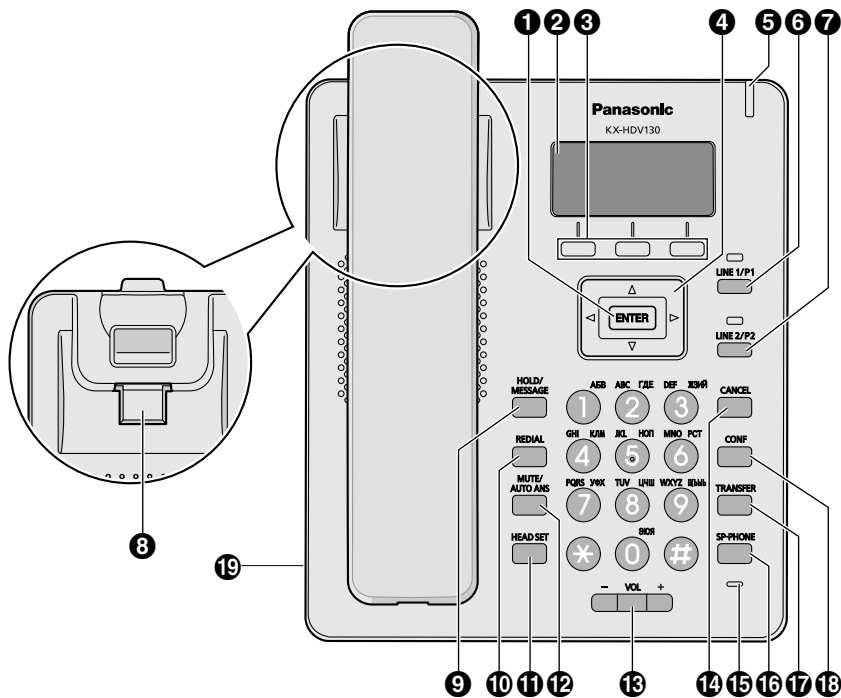

KX-HDV130

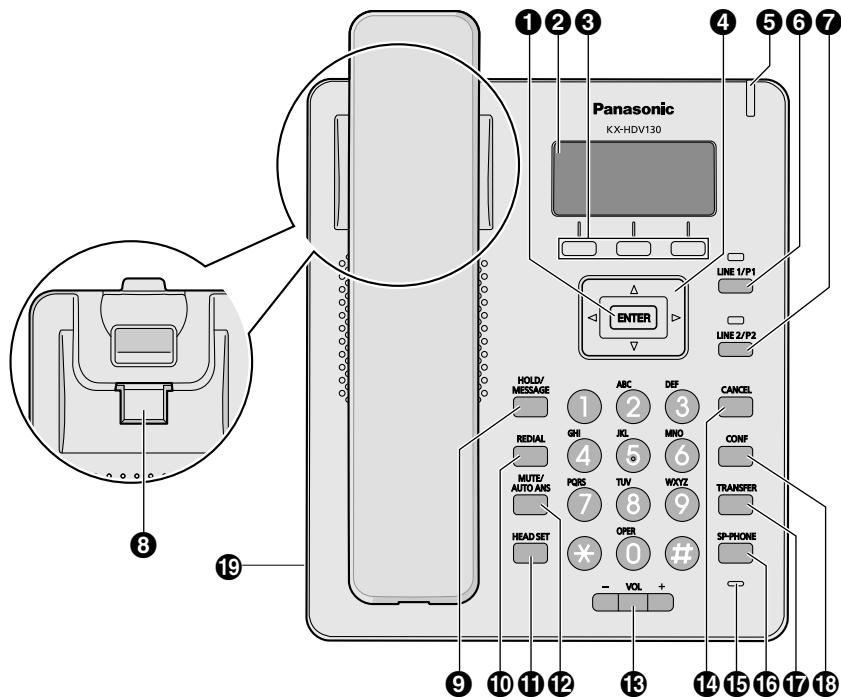

KX-HDV130C

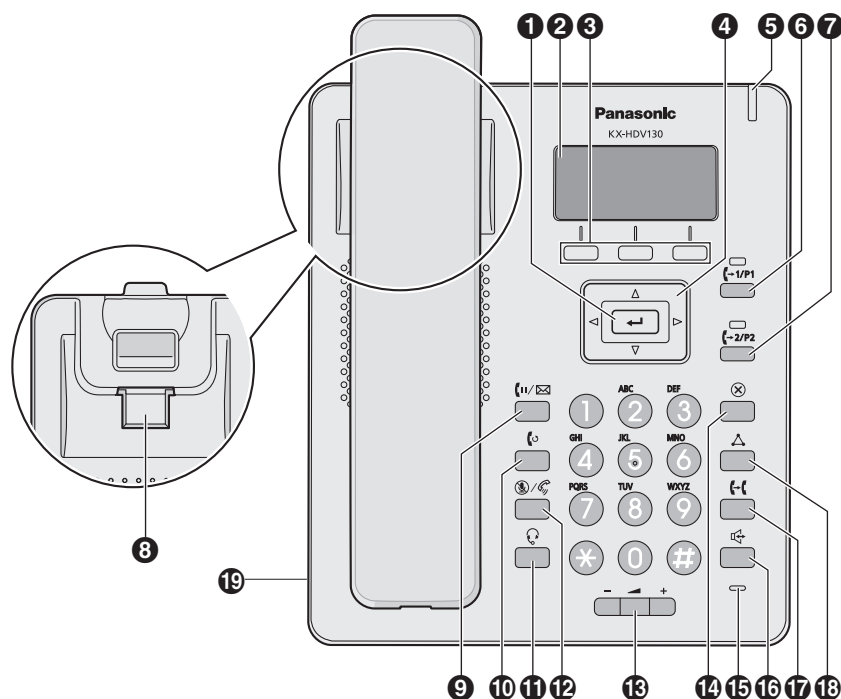

❶ **←/ ENTER**

Used to confirm the selected item.

❷ **LCD (Liquid Crystal Display)**

For more information, see "2.4.1 Main Display".

❸ **Soft Keys**

A/B/C (located from left to right) are used to select the item displayed on the bottom line of the display. For more information, see "2.6.1 Soft Keys".

❹ **Navigator Key**

The Navigator Key includes four direction keys. The direction keys are used to move the cursor to select an item. If in standby mode, pressing the keys perform the following functions:

- LEFT (◀): Used to display the Incoming call log.
- RIGHT (▶): Used to open the phonebook.
- DOWN (▼) → Long press: Used to display the line status.

Note

- When the BroadCloud (Presence) feature is enabled, the phone will operate as follows. Contact your administrator for further information.
 - LEFT (◀): Used to display Presence.
 - RIGHT (▶): Used to display Favorites.

❺ **Ringer / Message Waiting / Missed Call Indicator**

The lamp flashes when you are receiving a call, or when you have an unread message or missed call notification.

❻ **←/P1/ LINE 1/P1**

Used to perform the assigned function. When this key is assigned as a Line key, it can be used to confirm the status or seize line 1. For more information, see "4.5.2 The Types of Function Keys".

2.3 Location of Controls

7  **LINE 2/P2**

Used to perform the assigned function. When this key is assigned as a Line key, it can be used to confirm the status or seize line 2. For more information, see " 4.5.2 The Types of Function Keys".

8 **Handset Hook**

Keeps the handset stable when the unit is mounted on a wall. For more information, see "2.2.7 Hooking the Handset".

9  **HOLD/MESSAGE**

During talking, used to place a call on Hold. In standby mode, used to retrieve a call on hold if there is one, or used to access your voice mailbox if no call is on hold.

10  **REDIAL**

Used to redial the last dialed number.

11  **HEADSET**

Used for performing headset operations.

12  **MUTE/AUTO ANS**

Used to receive an incoming call in hands-free mode or mute the microphone/handset during a conversation.

13  **VOL**

Used to adjust the ringer/receiver volume.

14  **CANCEL**

Used to cancel the selected item.

15 **Microphone**

Used for hands-free conversation.

16  **SP-PHONE**

Used for performing hands-free operations.

17  **TRANSFER**

Used to transfer a call to another party.

18  **CONF**

Used to establish a multiple-party conversation.

19 **Headset Jack**

Optional headsets can be used with this unit. (Not all operations with the headsets can be guaranteed.) For up-to-date information about headsets that have been tested with this unit, refer to the following web site:

<https://panasonic.net/cns/pcc/support/sipphone/>

KX-HDV230NE

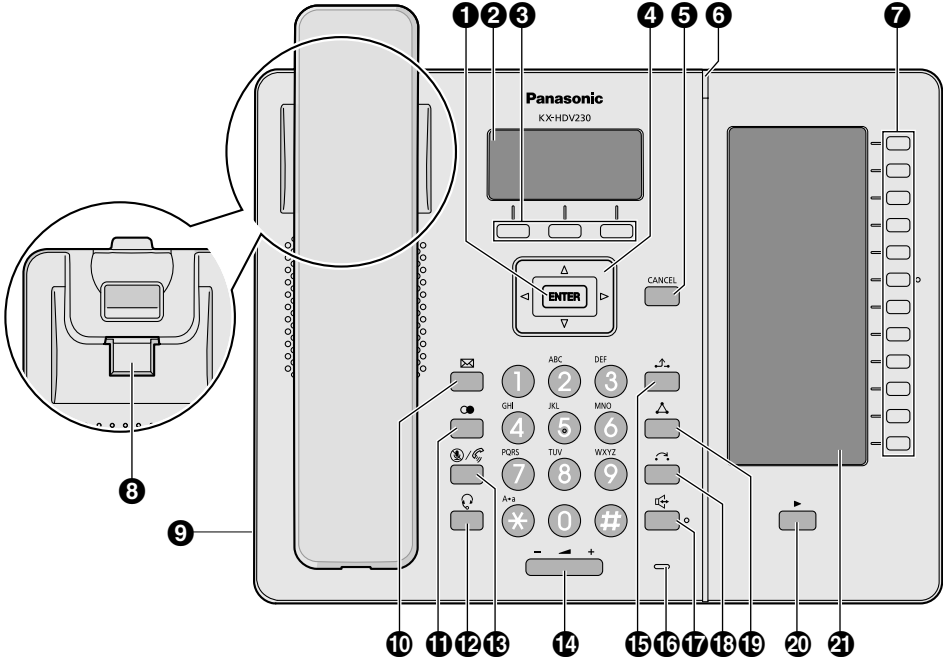

KX-HDV230X / KX-HDV230SX

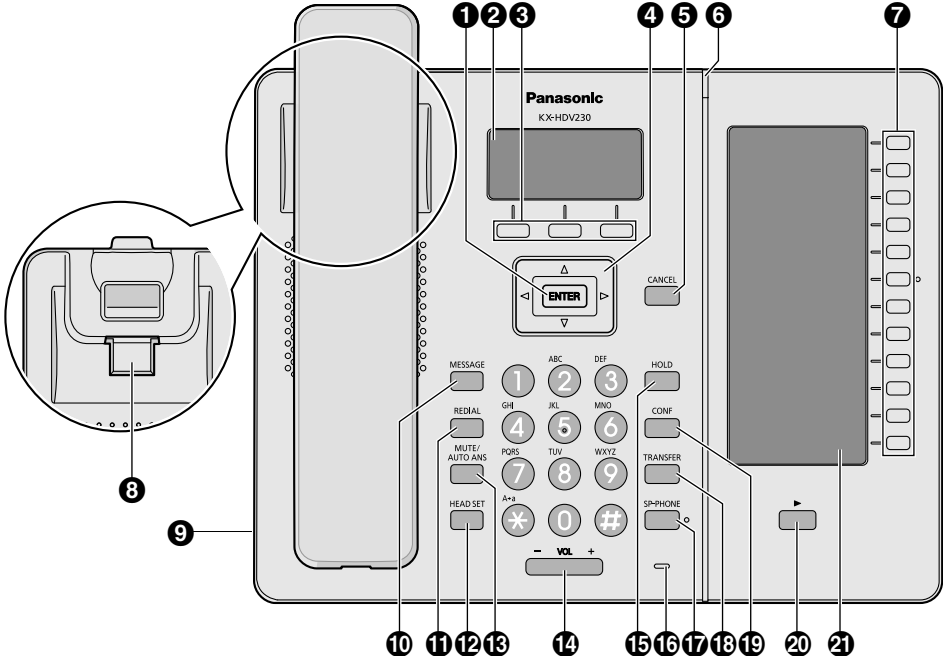

KX-HDV230RU

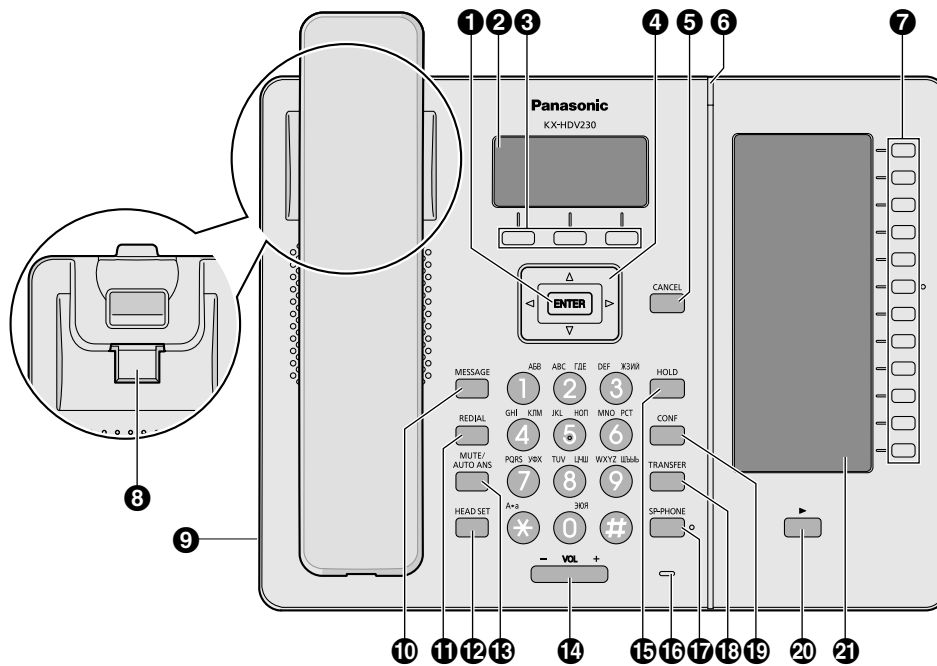

KX-HDV230

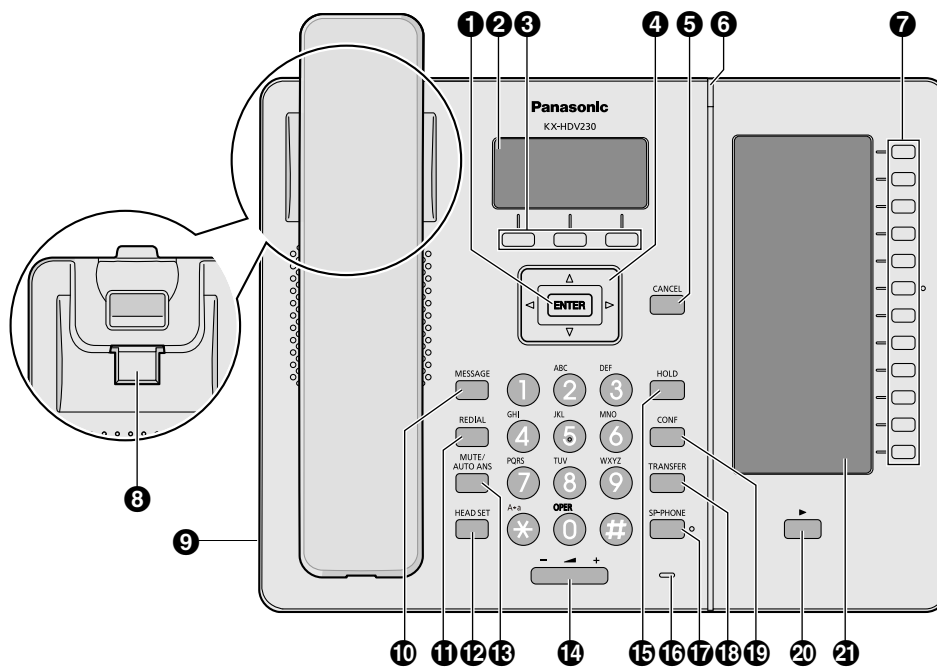

KX-HDV230C

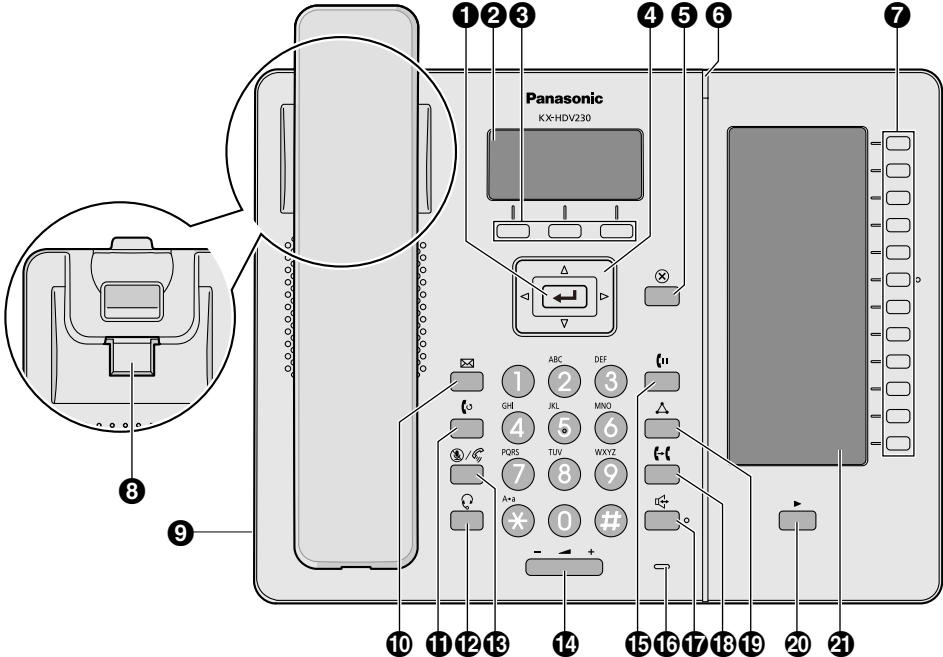

KX-HDV20NE / KX-HDV20X / KX-HDV20SX / KX-HDV20RU / KX-HDV20

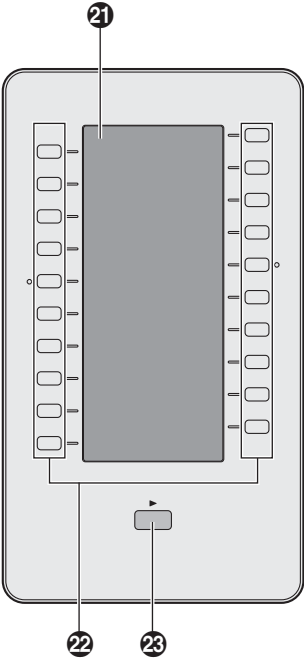

- 1 **←/ENTER**
Used to confirm the selected item.
- 2 **Main LCD (Liquid Crystal Display)**
For more information, see "2.4.1 Main Display ".

3 Soft Keys

A/B/C (located from left to right) are used to select the item displayed on the bottom line of the display. For more information, see "2.6.1 Soft Keys".

4 Navigator Key

The Navigator Key includes four direction keys. The direction keys are used to move the cursor to select an item. If in standby mode, pressing the keys perform the following functions:

- LEFT (◀): Used to display the Incoming call log.
- RIGHT (▶): Used to open the phonebook.
- DOWN (▼) → Long press: Used to display the line status.

Note

- When the BroadCloud (Presence) feature is enabled, the phone will operate as follows. Contact your administrator for further information.
 - LEFT (◀): Used to display Presence.
 - RIGHT (▶): Used to display Favorites.

5 ☒/ CANCEL

Used to cancel the selected item.

6 Ringer / Message Waiting / Missed Call Indicator

The lamp flashes when you are receiving a call, or when you have an unread message or missed call notification.

7 Program Keys [01–12] (Function Keys*)

Used to perform the assigned function. When a key is assigned as a Line Status key, it can be used to confirm the status of the line. The assigned key name can be confirmed on the self-labeling LCD. For more information, see "4.5.2 The Types of Function Keys".

8 Handset Hook

Keeps the handset stable when the unit is mounted on a wall. For more information, see "2.2.7 Hooking the Handset".

9 Headset Jack

Optional headsets can be used with this unit. (Not all operations with the headsets can be guaranteed.) For up-to-date information about headsets that have been tested with this unit, refer to the following web site:

<https://panasonic.net/cns/pcc/support/sipphone/>

10 ☒/ MESSAGE

Used to access your voice mailbox.

11 ☎/ REDIAL

Used to redial the last dialed number.

12 📞/ HEADSET

Used for performing headset operations.

13 📞/ MUTE/AUTO ANS



Used to receive an incoming call in hands-free mode or mute the microphone/handset during a conversation.

14 🔊/ VOL

Used to adjust the ringer/receiver volume.

15 📞/ HOLD

During talking, used to place a call on Hold. In standby mode, used to retrieve a call on hold if there is one.

- 16 Microphone**
Used for hands-free conversation.
- 17**  **SP-PHONE**
Used for performing hands-free operations.
- 18**  **TRANSFER**
Used to transfer a call to another party.
- 19**  **CONF**
Used to establish a multiple-party conversation.
- 20 Page Key**
Used to switch the page of program keys displayed on the self-labeling LCD. There are two pages of 12 program keys.
- 21 Self-labeling LCD**
For more information, see "2.4.2 Sub Display (Self-labeling LCD) (KX-HDV230 only)".
- 22 DSS Keys [01–20] (Function Keys^{*1})^{*2}**
Used to perform the assigned function. When a key is assigned as a Line key, it can be used to confirm the status of the line. The key name that you assigned is displayed on the KX-HDV20's self-labeling LCD.
For more information, see "4.5.2 The Types of Function Keys".
- 23 DSS Page Key^{*1}**
Used to switch the page of DSS keys displayed on the KX-HDV20 self-labeling LCD. There are two pages of 20 DSS keys.

^{*1} In this manual, "Function key" refers to both program keys and DSS keys.

^{*2} These keys can be used when you connect a KX-HDV20 to the unit.

Note

- "DSS" stands for "Direct Station Selection".

2.4 The Display and Icons

This section explains the keys and icons that appear on the display.

2.4.1 Main Display

[Example]

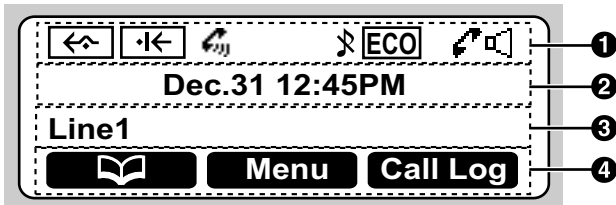

1 Status Icons

Suffix		Meaning
(none) / C	NE / RU / SX / X	
Fwd		Call Forwarding For more information, see "3.5.1 Setting Call Forwarding and Do Not Disturb".
DND		Do Not Disturb For more information, see "3.5.1 Setting Call Forwarding and Do Not Disturb".
Auto Ans.		Auto Answer
		Ringer Off For more information, see "Adjusting the Ringer Volume or Turning the Ringer Off while Ringing".
	ECO	ECO Mode For more information, see "4.8 Setting ECO Mode".
		Off-hook Monitor For more information, see "3.4.8 Using Off-hook Monitor".
		Training Mode (KX-HDV230 only) For more information, see "3.4.9 Using Training Mode (KX-HDV230 only)".
		Standby display page switcher

*1 This icon is displayed only for KX-HDV230.

2 Date and Time Display

3 Missed Call, New Message, or Name/Number Display

4 Soft Keys

For more information, see "2.6.1 Soft Keys".

Note

- In standby mode, the line name is displayed. In all other modes, if only one line is configured on the telephone, the line name is not displayed.

- Example images of the display in this manual are samples only, and the actual screen on your phone may vary in color and/or appearance.

2.4.2 Sub Display (Self-labeling LCD) (KX-HDV230 only)

[Example]

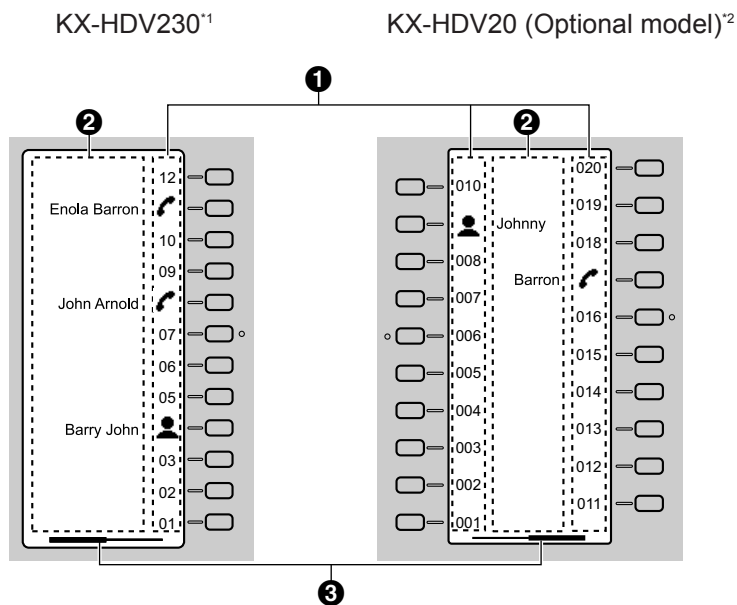

*1 Up to 24 keys (12 keys × 2 pages) can be registered.





*2 Up to 40 keys (20 keys × 2 pages) can be registered.

1 Pictographs

Pictograph	Meaning	Pictograph	Meaning
(Number)	No function is assigned.	📞	Phonebook
📞	One Touch Dial	📞	Call History
	Line		
	Line Status		
👤	BLF	📞	Simultaneous Ring
	Presence		ACD (Wrap Up)
			Directed Call Pickup
➡	ACD (Login)	📞	Group Pickup
	Hoteling/Hospitality		Call Forward
📞	Conference		📞
		Blind Transfer	
⏸	Application	📞	Park
			Park Retrieve

2 Function Label Name

3 Page Information

Indication	Meaning
	Displaying page 1
	Displaying page 1 with a call arriving at a BLF key on page 2
	Displaying page 2
	Displaying page 2 with a call arriving at a BLF key on page 1

Note

- Images of the display in this manual are samples only. The actual screen on your phone may vary in color and/or appearance.

2.5 Main Menu

Press **Menu** to display the following main menu.

Call Center/Call Centre^{*1}

Used to access the Call Center feature.

Presence^{*1}

Used to access the Presence feature.

FWD/DND^{*1}

Sets the Call Forwarding or Do Not Disturb features.
See "3.5.1 Setting Call Forwarding and Do Not Disturb".

Paging^{*1}

Makes a Multicast Voice Paging call.
See "3.1.3 Making a Multicast Voice Paging call".

New Phonebook

Adds a new entry into the local phonebook.
See "3.6.1 Storing an Item in the Local Phonebook".

Incoming Log

Used to display the incoming call log.
See "2.8.4 Using the Incoming/Outgoing Call Log".

Outgoing Log

Used to display the outgoing call log.
See "2.8.4 Using the Incoming/Outgoing Call Log".

Phonebook

Used to access the local or remote phonebook.
See "2.7 Phonebook".

ECO Mode

Sets the ECO mode feature.
See "4.8 Setting ECO Mode".

Line Status

Used to display the status of each line on the main LCD.
See "3.7 Checking the Line Status".

Basic Settings

Used to access the basic settings menu.
See "4.9 Changing the Basic Setting".

System Settings

Used to access the system settings menu.
See "4.10 Changing the System Settings".

Application^{*1}

Used to access the Application feature.

^{*1} This item is displayed only when the feature is enabled. Contact your administrator for further information.



2.6 Keys

2.6.1 Soft Keys

Icons and information shown on the display will vary depending on the context. To select an item shown on the display, press the corresponding soft key.



Icons may differ from the appearance of the actual product.

Soft Key A (Left Key)





Suffix		Meaning
(none) / C	NE / RU / SX / X	
		Opens the phonebook. Pressing this key for more than 2 seconds locks the phonebook.
	Back	Returns to the previous display.
		Displayed when in Phonebook Lock. Pressing this key and then entering the password (default: not registered), unlocks the phonebook temporarily. Pressing for more than 2 seconds, then entering the password (default: not registered), unlocks the phonebook. If no password has been set, you cannot lock the phonebook. For more information, see "4.2 Setting the Password".
	Answer	Answers a call.
Conf		Retrieves a conference on hold.
	Line ^{*1}	Opens the line selection screen.

*1 KX-HDV230 only

Soft Key B (Middle key)

Suffix		Meaning
(none) / C	NE / RU / SX / X	
	Menu	Opens the main menu.
	OK	Confirms the entry.
	Call	Makes a call.
		Turns the ringer off.
		Stores a new item in the phonebook.
		Answer a group call.

Soft Key C (Right key)

Suffix		Meaning
(none) / C	NE / RU / SX / X	
		Opens the Outgoing Call Log.
		Opens the Incoming Call Log.
	Blind	Performs an unscreened (blind) transfer.
	ABC	Displayed when in Latin character entry mode.
	0-9	Displayed when in Numeric character entry mode.
+###	###	Displayed when in Special character (Extended 1) entry mode.
	Reject	Used to reject an incoming call.
	Next	Advances to the next display.
	Clear	Clears digits or characters.
	Search	Searches for an item in the phonebook alphabetically.
	AM/PM	Used to select AM or PM when setting the time.
	Cancel	Used to cancel the setting.
	Delete	Used to delete the setting.
	Save	Used to save a setting.
	Ssš	Displayed when in Special character (Extended 2) entry mode.
Fwd/DND *1		Used to set Call Forwarding and Do Not Disturb.
	ABГ	Displayed when in Greek character entry mode.
	АБВ	Displayed when in Cyrillic character entry mode.
	HOT0 — HOT9 *1	Dials the number assigned to the Hot Key.
	Page *1 *2	Used to make a Multicast Voice Paging call.
	Park *1 *2	Used to retrieve a parked call (Call Parking).
	Call Log	Opens the call log.
	Recall *1	Disconnects the current call and allows you to make another call without hanging up.
	Pause *1 *2	Inserts a dialing pause.

*1 This soft key can be configured to appear as Soft Key A, B, or C.

*2 This soft key is displayed only when configured on the telephone.

2.7 Phonebook

The KX-HDV130 / KX-HDV230 has 2 types of phonebook.

1. Local Phonebook

This Phonebook is stored in the telephone.

You can store up to 500 phone numbers in the telephone along with names for easy access. You can also set unique ringer patterns for different categories to identify incoming calls.

All Phonebook items are stored in alphabetical order.

For security purposes, you can lock the Phonebook.

Note

- We recommend that backups are made of the phonebook data, in case the data becomes unrecoverable due to product malfunction.
- A single entry (i.e., name) can have multiple phone numbers. Since the phonebook capacity is limited by the number of stored phone numbers, storing multiple phone numbers in an entry decreases the maximum number of entries.
- Phonebook data can be imported and exported. Contact your administrator for further information. A name can have up to 24 characters. A telephone number can have up to 32 digits.

2. Remote Phonebook

If your telephone company provides the remote phonebook service, you can use it. For details, contact your phone system dealer/service provider.

You can refer to the Remote Phonebook in addition to the Local Phonebook, if the Remote Phonebook is available.

Note

- We recommend setting this feature with your administrator. Contact your administrator for further information.

	Local Phonebook	Remote Phonebook
Storing new items	✓	—
Editing stored items	✓	—
Deleting store items	✓	—
Searching the phonebook by name	✓	✓
Searching the phonebook by category	✓	—
Phone numbers for each item	Up to 5	Up to 5 ¹
Private Ring ²	✓	—
Locking the phonebook	✓	—

¹ This number depends on the service being used.

² You can organize entries in the Phonebook into one of 9 Private Ring Categories. It is possible to set a different ringer pattern for each category.

2.8 Basic Operations





This section explains the basics of using the unit.

2.8.1 Going off- and on-hook

Going off-hook

In this manual, when you see the phrase "off-hook", you can do any of the following:

[In standby mode]



- Lift the corded handset off its cradle.
- Press  / **SP-PHONE** while the corded handset is on its cradle.
This enables hands-free mode.
- Press  / **HEADSET** when using a headset.
- Press the corresponding key ( / **LINE 1/P1** or  / **LINE 2/P2**) to select a line (KX-HDV130 only).^{*1}
- Press the corresponding function key to select a line (KX-HDV230 only).^{*1}

^{*1} When a program key is assigned as a Line key, this feature is available.

Going on-hook

In this manual, when you see the phrase "on-hook", you can do any of the following:

[During a conversation]

- Replace the corded handset on its cradle.
- Press  / **SP-PHONE** when you are in hands-free mode.
- Press  / **HEADSET** when using a headset.
- Press  / **CANCEL**.

2.8.2 Adjusting the Volume

Adjusting the Receiver/Speaker/Headset Volume

1. Press the **[+]** or **[-]** volume key to adjust the volume during a conversation.

Note

- Both receiver volume and headset volume are adjusted in training mode. See "3.4.9 Using Training Mode (KX-HDV230 only)".

Adjusting the Ringer Volume or Turning the Ringer Off

1. In standby mode, press the **[+]** or **[-]** volume key to adjust the ringer volume.

Adjusting the Ringer Volume or Turning the Ringer Off while Ringing

While receiving a call, do the following to adjust the ringer volume or turn the ringer off.

Note

- If you attach a headset while receiving an incoming call, ringing will be heard from the speaker.

To adjust the ringer volume

1. Press the **[+]** or **[-]** volume key to adjust the ringer volume.

Note

- The adjusted volume level will also be used for subsequent calls.

2. Press **Back** to exit.

To turn the ringer off

1. Press **[Mute]**.

2.8.3 Entering Characters

You can enter characters and digits using the dialing keys.

You can select one of the character modes by pressing the Right Soft Key while entering a name. The function icon above the soft key displays the current character mode.

To change the character mode while editing a name in the Phonebook, press the Right Soft Key.

For available characters, see "5.1 Character Mode Table".

Suffix: [none] / C	Suffix: NE / X / SX	Suffix: RU
<p>ABC (Latin)</p> <p>↓</p> <p>0-9 (Numeric)</p> <p>↓</p> <p>+RÂ (Extended 1)</p>	<p>ABC (Latin)</p> <p>↓</p> <p>0-9 (Numeric)</p> <p>↓</p> <p>ABΓ (Greek)</p> <p>↓</p> <p>RÂÂ (Extended 1)</p> <p>↓</p> <p>SŠŠ (Extended 2)</p>	<p>АБВ (Cyrillic)</p> <p>↓</p> <p>0-9 (Numeric)</p> <p>↓</p> <p>ABC (Latin)</p> <p>↓</p> <p>RÂÂ (Extended 1)</p> <p>↓</p> <p>SŠŠ (Extended 2)</p>

- **Example: To enter "Anne" in Latin Mode**

[2] → [▶] → [✖] → [6] → [6] → [▶] → [6] → [6] → [▶] → [3] → [3]

- To switch between uppercase and lowercase, press [✖].
- To enter a character located on the same dialing key as the previous character, move the cursor by pressing the Navigator Key [▶], then enter the desired character.
- If you enter a different character by mistake, press the Navigator Key [◀] or [▶] to highlight the character, press **Clear** to delete it, then enter the correct character.
- To clear an entire line, press **Clear** for more than 1 second.

2.8.4 Using the Incoming/Outgoing Call Log

Displaying the Incoming Call Log

1. In standby mode, press [◀].
2. Press [▲] or [▼] to select "Incoming Call", and then press **OK**.

Note

- If "Missed Calls" is displayed on the LCD in standby mode, select "Missed Call" at step 2.

Displaying the Outgoing Call Log

1. In standby mode, press **Call Log**.
2. Press [▲] or [▼] to select "Outgoing Log", and then press **OK**.

Note

- If "Missed Calls" is displayed on the LCD in standby mode, select "Missed Call" at step 2.

Deleting Items in the Incoming/Outgoing Call Log

[When the Incoming or Outgoing Call Log is displayed]

1. Press [▲] or [▼] to select the desired item, and then press **Menu**.
2. Press [▲] or [▼] to select "Delete"^{*1}, and then press **OK**.
3. Press [▲] or [▼] to select "Yes", and then press **OK**.

*1 You can select "Delete All" instead to delete all items.

Section 3

Feature Operations

This section shows you step by step how to use each feature.

3.1 Making Calls

This section explains the basic methods for making a call.

- You can confirm that the number was dialed correctly before calling (Predialing) by entering the number, then going off-hook.
- To clear an entire number while predialing, press **Clear** for more than 1 second.
- To cancel dialing, press **⊗/CANCEL**.
- To insert a 3 second pause between phone numbers, press **Pause**.^{*1}
It is useful when you want to operate voice mail service without listening to pre-recorded announcement, for example. Repeat as needed to create longer pauses.
- The "+" symbol (international dialing code) can be entered by pressing and holding the **#** key.

^{*1} This soft key is displayed only when configured on the telephone. Contact your administrator for further information.

3.1.1 Basic Calling

Calling by Dialing

1. In standby mode, go off-hook.
2. Dial the outside party's number.
3. Press **Call**.
4. Go on-hook to end the call.

Note

- For KX-HDV130: You can use a specific line by pressing **←1/P1/****LINE 1/P1** or **←2/P2/****LINE 2/P2** assigned to a line or by using the Line Status screen (see "3.7 Checking the Line Status").
- For KX-HDV230: You can use a specific line by pressing a function key assigned to a line (see "4.5.2 The Types of Function Keys") or by using the Line Status screen (see "3.7 Checking the Line Status").
- To dial a new number without going on-hook, follow the procedure below.
 1. Press **Menu**.
 2. Press **[▲]** or **[▼]** to select "Flash/Recall".
 3. Press **OK**.

Predialing

In standby mode, you can start dialing while still on-hook. After dialing the number, go off-hook to begin the call.

3.1.2 Easy Dialing

Using the redial list

The last phone number dialed is stored in the redial list.

1. In standby mode, press **●/t/****REDIAL**.
2. Go off-hook.^{*1}

^{*1} When you do not go off-hook at this step, it will be a call using the speakerphone.

Note

- If this procedure is performed during a conversation, the conversation will end, and then redialing is performed.

Hot Key Dialing

You can assign a phone number to each number key and then access the desired phone number by simply pressing and holding the assigned number key. (See "4.4 Using Hot Keys".)

1. Press and hold the dialing key (0–9) assigned as a Hot Key for more than 1 second.
2. Go off-hook.

Note

- While the Hot Key's information is displayed, you can press [▲] or [▼] to select another Hot Key number.
- If Hot Key dialing is set to "Auto", a Hot Key number can also be dialed by pressing and holding the assigned dialing key for a specified number of seconds.

Using the Hot Line

If your administrator has configured this function, you can make a call to a registered phone number automatically. Contact your administrator for further information.

1. In standby mode, go off-hook.

Using the Incoming/Outgoing Call Log**Using the Incoming Call Log**

1. In standby mode, press [◀].
2. Press [▲] or [▼] to select "Incoming Log", and then press **OK**.
3. Press [▲] or [▼] to select an incoming call log.
4. Go off-hook.

Note

- If "Missed Calls" is displayed on the LCD in standby mode, you can select "Missed Calls" at step 2 to select a number to call.

Using the Outgoing Call Log

1. In standby mode, press **Call Log**.
2. Press [▲] or [▼] to select "Outgoing Log", and then press **OK**.
3. Press [▲] or [▼] to select an outgoing call log.
4. Go off-hook.

Using the Phonebook**Using the Local Phonebook**

1. In standby mode, press **Phonebook**.
2. Press [▲] or [▼] to select "Phonebook"¹, and then press **OK**.

3.1.3 Making a Multicast Voice Paging call

3. Enter the name or the first character(s) of the desired name, and then press **OK**.
4. Press [▲] or [▼] to select the desired item, and then press ↵/ENTER.²
5. Press [▲] or [▼] to select the desired phone number.
6. Go off-hook.

¹ If only Local Phonebook is permitted, this step is skipped.

² If you push and hold [▲] or [▼], the next/previous items will be displayed automatically.

Note

- If the Local Phonebook is not permitted, this feature cannot be used. Contact your administrator for further information.

Using the Remote Phonebook

You can refer to the Remote Phonebook in addition to the Local Phonebook, if the Remote Phonebook is available.

1. In standby mode, press **📖**.
2. Press [▲] or [▼] to select "Remote Phonebook"¹, and then press **OK**.
3. Enter the name or the first character(s) of the desired name, and then press **OK**.
4. Press [▲] or [▼] to select the desired item, and then press **OK**.²
5. Press [▲] or [▼] to select the desired phone number.
6. Go off-hook.

¹ If only Remote Phonebook is permitted, this step is skipped.

² If you push and hold [▲] or [▼], the next/previous items will be displayed automatically.

Note

- If the Remote Phonebook is not permitted, this feature cannot be used. Contact your administrator for further information.

3.1.3 Making a Multicast Voice Paging call

When you make a paging call, the voice will be heard through the speaker phone of the other telephones.



1. In standby mode, press **Menu**.
2. Press [▲] or [▼] to select "Paging"¹, and then press **OK**.
3. Press [▲] or [▼] to select a desired channel group², and then press **OK**.

¹ Paging is available only when the feature is enabled. Contact your administrator for further information.

² If there is only 1 channel group, paging will start immediately.

3.2 Receiving Calls

This section explains the basic methods for receiving a call.

- You can select the ringer for each type of incoming call.
- You can also use Auto Answer to answer a call.
- In standby mode, press  /  / **MUTE/AUTO ANS** to toggle Auto Answer on or off.
- The volume of the ringer can be adjusted, or turned off. (See "2.8.2 Adjusting the Volume".)
- If an outside call is received from a phone number stored in the Phonebook, the number and name of the caller will be displayed in the call log.
- If you attach a headset while receiving an incoming call, ringing will be heard from the speaker. Depending on the headset, ringing may be heard through the headset.
- Up to 24 calls can be received at the same time. The 25th caller will hear a busy tone (KX-HDV230 only).

3.2.1 Answering Calls

To answer an incoming call

1. While receiving an incoming call, go off-hook.^{*1}
- ^{*1} When the handset is already off-hook, press and release the hook switch.

Note

- When a call is received while another call is on hold, pressing and releasing the hook switch will answer the call.

To answer an incoming call on a specific line

1. For KX-HDV130: While receiving an incoming call, press the corresponding key (\leftarrow 1/P1/ **LINE 1/P1**) or (\leftarrow 2/P2/ **LINE 2/P2**).
- For KX-HDV230: While receiving an incoming call, press the corresponding function key.

Note

- When a program key is assigned as a Line key, this feature is available.
- Line keys with incoming calls will be flashing blue rapidly.
- You can select the ringer pattern for each type of incoming call.

To answer an incoming call when receiving multiple incoming calls (KX-HDV230 only)

1. While receiving an incoming call, press **Line**.
2. Press [**▲**] or [**▼**] to select an incoming call, and then press **Answer**.
3. Go off-hook.

To reject an incoming call

1. While receiving an incoming call, press **Reject**.
The call will be rejected, and the telephone will return to standby mode.

3.2.1 Answering Calls



Note

- Calls from specific numbers can be automatically rejected. For details, see "4.7 Barring Incoming Calls (Caller ID¹ service users only)".

3.3 Using Hands-free Mode

In hands-free mode, you can talk and hear the other party in a conversation without using the handset. This mode is useful for performing other tasks during a conversation, such as writing.

Enabling hands-free mode

- If you press / **SP-PHONE** in standby mode, you can enable hands-free mode.
- During a conversation using a headset, you can enable hands-free mode by pressing / **SP-PHONE**.

Canceling hands-free mode

You can cancel hands-free mode in one of the following ways:

- During a conversation in hands-free mode, go off-hook.
- While you are talking in hands-free mode and a headset is attached to the unit, press / **HEADSET** to continue the conversation using the headset.

3.4 During a Conversation

3.4.1 Transferring a Call (Call Transfer)

You can transfer a call to another destination (extension or outside party).

To transfer

1. Press /t/ **TRANSFER** during a conversation.
2. Dial the party you want to transfer to ^{*1}, and then press **Call**.
3. Do one of the following:
 - a. Confirmation Transfer: Wait until the other party answers and then go on-hook.
 - b. Automatic Transfer: Go on-hook before the other party answers.

^{*1} You can also select a phone number from the call history or the phonebook.

Note

- To return to the call before the transfer destination answers, press / **CANCEL**.

To do a blind transfer

1. Press **Blind** during a conversation.^{*1}
2. Dial the party you want to transfer to^{*2}, and then press **Call**.

^{*1} If blind transfers are not permitted, **Blind** is not displayed. Contact your administrator for further information.

^{*2} You can also select a phone number from the call history or the phonebook.





3.4.2 Holding a Call

You can put a call on hold by holding the call at your extension.

Note

- Operation for this feature may differ depending on the telephone's configuration. If the following procedure does not work, contact your administrator for further information.

To hold the current call

1. For KX-HDV130: Press / /t/ / **HOLD/MESSAGE** during a conversation.
For KX-HDV230: Press /t/ **HOLD** during a conversation.

Note

- When a program key is assigned as a Line key, if you press a Line key other than the one for the current call, the call is put on hold or is disconnected depending on the Automatic Call Hold settings. For details, contact your phone system dealer/service provider.

To retrieve a call on hold at your line (For KX-HDV130)

1. Press / /t/ / **HOLD/MESSAGE**. ^{*1}

^{*1} When the handset is already off-hook, press and release the hook switch.

Note

- When a call is received while another call is on hold, pressing and releasing the hook switch will answer the call.
- If t-1/P1 /**LINE 1/P1** or t-2/P2 /**LINE 2/P2** key is assigned as a Line key, and a call is on hold on that line, you can retrieve the call on hold by following the step below.
 1. Press the corresponding t-1/P1 /**LINE 1/P1** or t-2/P2 /**LINE 2/P2** key.

To retrieve a call on hold at your line (For KX-HDV230)

1. Press t-1/P1 /**HOLD**.
2. When two or more lines are on hold, press [**▲**] or [**▼**] to select a line on hold, and then press **OK**.

Note

- When a call is received while another call is on hold, pressing and releasing the hook switch will answer the call.
- If a function key is assigned as a Line key, and a call is on hold on that line, you can retrieve the call on hold by following the step below.
 1. Press the corresponding function key.

3.4.3 Holding in a System Parking Zone (Call Park)

You can use this feature as a transferring feature.

When Call Park is permitted, the **Park** soft key is displayed. However, the Call Park feature number must be set beforehand. Also, depending on your phone system, you may need to enter a parking zone number to retrieve a parked call. The feature depends on your phone system. Contact your administrator for further information.

To set

1. Press **Park** key during a conversation.
Or press an unused (LED is off) function key to which the Call Park function is assigned (KX-HDV230 only).
2. Go on-hook or press **OK**.

To retrieve (Call Park Retrieve)

1. In standby mode, enter the Call Park Retrieve feature number.
Or press a function key in use (blue LED is slowly flashing, or red LED is slowly flashing) to which the Call Park function is assigned (KX-HDV230 only).
2. Go off-hook.

Note

- Depending on the telephone system, the **Park** soft key might blink to show that the line has a parked call. In this case, you can retrieve the call by pressing the blinking **Park** soft key. However, to retrieve a parked call using the soft key, the Call Park Retrieve feature number must be set beforehand. Contact your administrator for further information.

3.4.4 Talking to Two Parties Alternately (Call Splitting)

When talking to one party while the other party is on hold, you can swap the calls back and forth (alternately).

To alternate between the parties leaving one party on hold temporarily (For KX-HDV130)

1. Press Δ / \square / \square / \square /HOLD/MESSAGE during a conversation.
2. Dial the other party's extension number, and then press \leftrightarrow /ENTER.
3. After talking to the other party, press Δ / \square / \square / \square /HOLD/MESSAGE.
4. Talk to the original party.

To alternate between the parties leaving one party on hold temporarily (For KX-HDV230)

1. Press Δ / \square /HOLD during a conversation.
2. Dial the other party's extension number, and then press \leftrightarrow /ENTER.
3. After talking to the other party, press **Line**.
4. Press [\blacktriangle] or [\blacktriangledown] to select the original party, and then press **OK**.
5. Talk to the original party.

3.4.5 Making a Three-party Conference

During a conversation, you can add an additional party to your call and establish a conference call.

Note

- Your phone system may support advanced conference features, such as conference calls with four or more parties. In this case, the procedures for handling a conference call may be different from those explained in this section. For details, contact your phone system dealer/service provider.

Making a Conference Call

1. Press Δ /CONF during a conversation.
2. Dial the party you want to add to the conversation, and then press **Call**.
3. Press Δ /CONF.

Removing a Party from the Conference (For KX-HDV130)

During a conference, you can remove other parties from the conference. However, this operation is available only during conference calls you initiate.

Note

- To reestablish the conference without removing either party, press Δ /CONF after step 2 whether on-hook or off-hook.

1. During a conference call, press Δ / \square / \square / \square /HOLD/MESSAGE.
2. Press the corresponding key (\leftarrow VP1/LINE 1/P1 or \leftarrow VP2/LINE 2/P2) for the party you want to disconnect¹.

3. Talk to the party and go on-hook to end the call.
 4. Go off-hook and talk to the remaining party.
- *1 When a program key is assigned as a Line key, this feature is available.

Removing a Party from the Conference (For KX-HDV230)

During a conference, you can remove other parties from the conference. However, this operation is available only during conference calls you initiate.

1. During a conference call, press $\mathcal{A}/\mathcal{M}/\boxed{\text{HOLD}}$.
2. Press $\mathcal{A}/\mathcal{M}/\boxed{\text{HOLD}}$ again to show the conference parties on hold.
3. Press \blacktriangle or \blacktriangledown to select the party to remove, and then press **OK**.
4. Talk to the party and go on-hook to end the call.
5. Press $\mathcal{A}/\mathcal{M}/\boxed{\text{HOLD}}$.

Ending a Conference Call

To end the conference call, go on-hook.

3.4.6 Muting the Microphone or the Handset

You can disable the microphone or the handset to consult privately with others in the room while listening to the other party on the phone through the speaker or the handset.

To set/cancel

1. Press $\mathcal{M}/\mathcal{A}/\boxed{\text{MUTE/AUTO ANS}}$.

Note

- When the \mathcal{M} icon is blinking on the LCD, Mute is on.
- During Mute, even if you switch from/to speakerphone, Mute will continue.
- During Mute, even if you connect/disconnect a headset, Mute will continue.

3.4.7 Using Call Waiting

During a conversation, if a second call arrives, you will hear a call waiting tone. You can answer the second call by disconnecting or holding the current call. This is an optional telephone company service. You can receive a call waiting tone and the caller's information. For details, contact your phone system dealer/service provider.

To disconnect the current call and then talk to the new party

1. Go on-hook.
2. Go off-hook.

To hold the current call and then talk to the new party

1. Press **Answer**.

Note

- For KX-HDV130: You can also answer the call by pressing $\mathcal{A}/\mathcal{M}/\mathcal{M}/\mathcal{A}/\boxed{\text{HOLD/MESSAGE}}$.
- For KX-HDV230: You can also answer the call by pressing $\mathcal{A}/\mathcal{M}/\boxed{\text{HOLD}}$.

3.4.8 Using Off-hook Monitor

During a two-party conversation with the corded handset, you can allow other people to listen to the conversation through the speaker while you continue the conversation using the corded handset.

To start/To cancel

1. Press /SP-PHONE during a conversation.

Note

- When off-hook monitor is active, replacing the corded handset to its cradle enables hands-free mode.

3.4.9 Using Training Mode (KX-HDV230 only)

In training mode, you can hear the other party in a conversation from both a headset and the handset. This mode is useful for training an operator. While the operator talks to the other party on the headset, a trainer also can listen to the other party on the handset and teach the operator how to respond to the caller.

Starting training mode

1. During a conversation using a headset, go off-hook by lifting the handset off its cradle.
2. Press /HEADSET to start training mode.

Ending training mode

1. Replace the handset on its cradle.
The conversation will continue using the headset.

3.5 Before Leaving Your Desk

3.5.1 Setting Call Forwarding and Do Not Disturb

You can have incoming calls automatically forwarded to another destination. You can also have incoming calls rejected (Do Not Disturb).

1. Press **Menu**.
2. Press [**▲**] or [**▼**] to select "FWD/DND", and then press **OK**.
3. If the unit has multiple lines, press [**▲**] or [**▼**] to select the desired line, and then press **OK**.
4. Press [**▲**] or [**▼**] to select the type of FWD or DND setting to apply, and then press **OK**.
The settings are as follows.
 - "DND"
(All incoming calls are automatically rejected.)
 - "Fwd(All)"
(All incoming calls are forwarded.)
 - "Fwd(Busy)"
(Incoming calls are forwarded only when your extension is in use.)
 - "Fwd(NA)"
(An incoming call is forwarded if you do not answer the call within a certain amount of time.)
5. To set "DND"
 - a. Press [**▲**] or [**▼**] to select "On" or "Off".
 - b. Press **OK**.
6. To set "Fwd(All)" or "Fwd(Busy)"
 - a. Press [**▲**] or [**▼**] to select "On/Off", and then press **OK**.
 - b. Press [**▲**] or [**▼**] to select "On" or "Off" and then press **OK**.¹
 - c. Press [**▲**] or [**▼**] to select "Phone Number", enter a forward destination phone number, and then press **OK**.²
7. To set "Fwd(NA)"
 - a. Press [**▲**] or [**▼**] to select "On/Off", and then press **OK**.
 - b. Press [**▲**] or [**▼**] to select "On" or "Off" and then press **OK**.¹
 - c. Press [**▲**] or [**▼**] to select "Phone Number", enter a forward destination phone number, and then press **OK**.²
 - d. Press [**▲**] or [**▼**] to select "Ring Count", enter the number of rings before the call is forwarded, and then press **OK**.³

¹ When you select "Off", the subsequent operations can be omitted.

² When "Phone Number" is already set, this step can be omitted.

³ When "Ring Count" is already set, this step can be omitted.

Note

- When Call Forwarding and/or Do Not Disturb is enabled, **←** / **Fwd** and/or **·←** / **DND** appears on the display in standby mode.

3.6 Using the Phonebook

3.6.1 Storing an Item in the Local Phonebook

Storing a New Item

1. In standby mode, press **Menu**.
2. Press [**▲**] or [**▼**] to select "New Phonebook", and then press **OK**.
 - a. Enter a name (max. 24 characters), and then press **OK**.
3. Press [**▲**] or [**▼**] to select a phone number type (**1** to **5**), and then press **OK**.¹
 - a. Enter the phone number (max. 32 digits), and then press **OK**.
4. Press [**▲**] or [**▼**] to select "Category Off", and then press **OK**.²
 - a. Select a category, and then press **OK**.
5. To select a default number for the entry, press [**▲**] or [**▼**] to select "Default TEL No", and then press **OK**.³
 - a. Press [**▲**] or [**▼**] to select the number to use as the default number, and then press **OK**.³
6. Press **Save**.

¹ Repeat this step to add additional phone number types.

² This step can be omitted if you do not want to assign a category.

³ This step can be omitted if you do not want to assign a default number.

(The first number entered for an entry will automatically be assigned as the default number.)

Note

- The valid digits are "0" through "9", "✳", "##", "+", "P".
- To enter characters, see "2.8.3 Entering Characters".

Storing an Item Using the Dialing

You can dial a number first and then add it as a phonebook entry.

To add a new entry using the dialing

1. In standby mode, dial a number.
2. Press **☎**.
 - a. Enter a name (max. 24 characters), and then press **OK**.
3. Press [**▲**] or [**▼**] to select a phone number type (**1** to **5**), and then press **OK**.¹
 - a. Edit the phone number if desired, and then press **OK**.
4. Press [**▲**] or [**▼**] to select "Category Off", and then press **OK**.²
 - a. Select a category, and then press **OK**.
5. To select a default number for the entry, press [**▲**] or [**▼**] to select "Default TEL No", and then press **OK**.³
 - a. Press [**▲**] or [**▼**] to select the number to use as the default number, and then press **OK**.

6. Press **Save.**

¹ Repeat this step to add additional phone number types.

² This step can be omitted if you do not want to assign a category.

³ This step can be omitted if you do not want to assign a default number. (The first number entered for an entry will automatically be assigned as the default number.)

Note

- The valid digits are "0" through "9", "✳", "✳", "✳", "P".
- To enter characters, see "2.8.3 Entering Characters".

Storing an Item Using the Incoming or Outgoing Call Log

You can add a number listed in the Incoming or Outgoing Call Log to the Local Phonebook.

To add a new entry

1. In standby mode, display the Incoming or Outgoing Call Log (see 2.8.4 Using the Incoming/Outgoing Call Log).
2. Press [▲] or [▼] to select the desired item, and then press **OK**.
3. Press [▲] or [▼] to select "Save Phonebook", and then press **OK**.
 - a. Edit the name if desired, and then press **OK**.
4. Press [▲] or [▼] to select a phone number type (1 to 5), and then press **OK**.¹
 - a. Edit the phone number if desired, and then press **OK**.
5. Press [▲] or [▼] to select "Category Off", and then press **OK**.²
 - a. Select a category, and then press **OK**.
6. To select a default number for the entry, press [▲] or [▼] to select "Default TEL No", and then press **OK**.³
 - a. Press [▲] or [▼] to select the number to use as the default number, and then press **OK**.
7. Press **Save**.

¹ Repeat this step to add additional phone number types.

² This step can be omitted if you do not want to assign a category.

³ This step can be omitted if you do not want to assign a default number. (The first number entered for an entry will automatically be assigned as the default number.)

Note

- The valid digits are "0" through "9", "✳", "✳", "✳", "P".
- To enter characters, see "2.8.3 Entering Characters".

3.6.2 Editing a stored item in the Local Phonebook**Editing a Stored Item**

1. In standby mode, press **Phonebook**.
2. Press [▲] or [▼] to select "Phonebook"¹, and then press **OK**.
3. Enter the name or the first character(s) of the desired name, and then press **OK**.
4. Press [▲] or [▼] to select the desired name, and then press **Menu**.

3.6.3 Deleting a Stored Item in the Local Phonebook

5. Press [▲] or [▼] to select "Edit", and then press **OK**.
6. Press [▲] or [▼] to select the desired name, phone number, category or default telephone number, and then press **OK**.
7. Edit the data as necessary, and then press **OK**.
8. Repeat step 6 to 7 and edit the items you want to change.
9. Press **Save**.

^{*1} Depending on your service provider, there are cases where this menu does not appear. In this case, step 2 is skipped.

Note

- To change a character or digit, press [◀] or [▶] to highlight it, press **Clear** to delete it, and then enter the new character or digit.
- To clear an entire line, press and hold **Clear** for more than 1 second.
- To move the cursor to the left or right, press [◀] or [▶] respectively.
- To enter characters, see "2.8.3 Entering Characters".

Editing Category Names

You can edit the names of the categories in the phonebook.

1. In standby mode, press **Menu**.
2. Press [▲] or [▼] to select "Basic Settings", and then press **OK**.
3. Press [▲] or [▼] to select "Display Option", and then press **OK**.
4. Press [▲] or [▼] to select "Category Name", and then press **OK**.
5. Press [▲] or [▼] to select the desired category number (1–9), and then press **OK**.
6. Enter a name for the category (max. 13 characters), and then press **OK**.
7. Repeat steps 5 and 6 for each category name to edit.

Note

- To enter characters, see "2.8.3 Entering Characters".

3.6.3 Deleting a Stored Item in the Local Phonebook

1. In standby mode, press **☰**.
2. Press [▲] or [▼] to select "Phonebook" ^{*1}, and then press **OK**.
3. Enter the name or the first character(s) of the desired name, and then press **OK**.
4. Press [▲] or [▼] to select the desired item.
5. Press **Menu**.
6. Press [▲] or [▼] to select "Delete Number" ^{*2}, and then press **OK**.
7. Press [▲] or [▼] to select "Yes", and then press **OK**.

^{*1} Depending on your service provider, there are cases where this menu does not appear. In this case, step 2 is skipped.

^{*2} To delete all items, select "Delete All" instead of "Delete Number".

3.6.4 Searching for an Item in the Local Phonebook

Searching by Name

You can also search for an item in the phonebook by entering a name.

1. In standby mode, press .
2. Press [▲] or [▼] to select "Phonebook" ^{*1}, and then press **OK**.
3. Enter the name or the first character(s) of the desired name, and then press **OK**.
4. Press [▲] or [▼] to select the desired item, and then press ↵/ENTER.^{*2}
5. Press [▲] or [▼] to select the desired phone number.
6. To make a call, go off-hook.

^{*1} If only Local Phonebook is permitted, this step is skipped.

^{*2} If you push and hold [▲] or [▼], the next/previous items will be displayed automatically.

Note

- To enter characters, see "2.8.3 Entering Characters".

Searching by Category

If items in the phonebook have been assigned categories, you can search by category.

1. In standby mode, press .
2. Press [▲] or [▼] to select "Phonebook" ^{*1}, and then press **OK**.
3. Press **#**.
4. Press [▲] or [▼] to select a category, and then press **OK**.
5. Enter the name of the item in the category, and then press **OK**.
6. Press [▲] or [▼] to select the desired item.
7. To make a call, go off-hook.

^{*1} If only Local Phonebook is permitted, this step is skipped.

Note

- To enter characters, see "2.8.3 Entering Characters".

Searching by pressing Dial Keys

You can also search for an item in the phonebook by pressing multiple dial keys when the phonebook list is displayed.

1. When the phonebook is displayed, press the dial keys to enter the first character(s) of the desired name in accordance with the character tables.
2. Press ↵/ENTER.

3.6.5 Locking/Unlocking the Local Phonebook

Character table

Suffix	NE / X / SX / C / (none)	NE / X / SX	RU
Keys	ABC (Latin)	ΑΒΓ (Greek)	АБВ (Cyrillic)
[1]	# → * → 1	# → * → 1	А → Б → В → # → * → 1
[2]	A → B → C → 2	Α → Β → Γ → 2	Г → Д → Е → Ё → А → В → С → 2
[3]	D → E → F → 3	Δ → Ε → Ζ → 3	Ж → З → И → Й → 3 → D → E → F → 3
[4]	G → H → I → 4	Η → Θ → Ι → 4	К → Л → М → 4 → G → H → I → 4
[5]	J → K → L → 5	Κ → Λ → Μ → 5	Н → О → П → 5 → J → K → L → 5
[6]	M → N → O → 6	Ν → Ξ → Ο → 6	Р → С → Т → 6 → М → N → О → 6
[7]	P → Q → R → S → 7	Π → Ρ → Σ → 7	У → Ф → Х → 7 → P → Q → R → S → 7
[8]	T → U → V → 8	Τ → Υ → Φ → 8	Ц → Ч → Ш → 8 → Т → U → V → 8
[9]	W → X → Y → Z → 9	Χ → Ψ → Ω → 9	Щ → Ъ → Ы → Ь → 9 → W → X → Y → Z → 9
[0]	0 → Space	0 → Space	Э → Ю → Я → 0 → Space

- Pressing a key repeatedly will cycle through the characters associated with that key. For example, to enter the letter "C" in Latin Mode, press [2] 3 times.
- The illustrations of the keys in the table may differ in appearance from the actual keys on the telephone.

Example: To enter "ANNE" in Latin Mode

[2] → [6] → [6] → [▶] → [6] → [6] → [3] → [3]

Note

- Availability depends on your phone system. Contact your administrator for further information.

3.6.5 Locking/Unlocking the Local Phonebook

You can lock/unlock the phonebook while in standby mode.

If no password has been set, you cannot lock the phonebook.

For details about setting the password, see "4.2 Setting the Password".

Locking the Phonebook



- Press and hold  for more than 2 seconds.^{*1}

-  will be displayed.

^{*1} The call log is also locked.

If the password is not set, an error tone sounds and the error message "Password Not Stored" is displayed.

Unlocking the Phonebook

- Press and hold  for more than 2 seconds.
- Enter your password.^{*1}
- To return to standby mode, press  / [CANCEL].

^{*1} If you enter an incorrect password 3 times, you cannot enter another password for approximately 30 seconds.

Unlocking the Phonebook Temporarily

1. Press .

2. Enter your password.^{*1}

^{*1} If you enter an incorrect password 3 times, you cannot enter another password for approximately 30 seconds.

3.6.6 Searching for an Item in the Remote Phonebook

1. In standby mode, press .

2. Press [▲] or [▼] to select "Remote Phonebook" ^{*1}, and then press **OK**.

3. Enter the name or the first character(s) of the desired name, and then press **OK**.

4. Press [▲] or [▼] to select the desired item, and then press **OK**.^{*2}

5. Press [▲] or [▼] to select the desired phone number.

6. To make a call, go off-hook.

^{*1} If only Remote Phonebook is permitted, this step is skipped.

^{*2} If you push and hold [▲] or [▼], the next/previous items will be displayed automatically.

Note

- To enter characters, see "2.8.3 Entering Characters".

3.7 Checking the Line Status

You can check the status of each line (KX-HDV130: up to 2 lines, KX-HDV230: up to 6 lines) on the display.

In Standby Mode

1. Press **Menu**.
2. Press [▲] or [▼] to select "Line Status", and then press **OK**.
3. Press [▲] or [▼] to select the line whose status you want to check.
4. Press ⊗/ **CANCEL** to end checking the line status or press **OK** to perform an action.

Note

- When a function key is assigned as a Line Status key, you can press that function key to display the line status screen.

During a Conversation

1. Press **Line**.
2. Press [▲] or [▼] to select the line whose status you want to check.
3. Press ⊗/ **CANCEL** to end checking the line status or press **OK** to perform an action.

Note

- When a function key is assigned as a Line Status key, you can press that function key to display the line status screen.

Line status indication

Status Display	Meaning	Action
Free ^{*1}	The line is idle.	Seize the line for dialing.
<n> Free ^{*1}	A shared line is idle.	Seize the line for dialing.
In Use (KX-HDV230 only)	The line is on a call.	—
Line On Hold ^{*2}	The line is on hold.	Retrieve the call on hold.
Incoming Call (KX-HDV230 only) ^{*2}	The line is receiving a call.	Answer the call.
Recall (KX-HDV230 only) ^{*2}	The line is receiving a Hold Recall signal.	Answer the call.
<x> In Use ^{*3}	A shared line is in use at another unit.	Join the call.
<x> Line On Hold ^{*3}	A shared line is on hold at another unit.	Retrieve the call on hold.

^{*1} The following icons are also displayed if the corresponding feature is enabled.

Icon	Meaning
	Call Forwarding
	Do Not Disturb
	Making an anonymous call

Icon	Meaning
	Block anonymous calls

- *2 When the line is in this state, call information is also displayed.
- *3 If the shared line is set, <x> (index number) is also displayed. We recommend setting this with your administrator. Contact your administrator for further information.

3.8 Listening to Voice Mail Messages

When you receive a voice message, "Voice MSG" is displayed.
You can check your new messages by accessing your mailbox.

1. In standby mode, press \uparrow / \downarrow / \square / \square / \square / \square /[HOLD/MESSAGE] (KX-HDV130)^{*1}.
2. Press [\blacktriangle] or [\blacktriangledown] to select the line on which \square is displayed, and then press **OK**.

^{*1} For KX-HDV230, press \square /[MESSAGE].

Note

- Step 2 is not necessary if only one line is configured on the telephone.

Section 4

Customizing the Telephone

This section shows you how to customize your individual telephone according to your needs.

4.1 Setting the LCD Display

Changing the Telephone's LCD Display

You can change what is displayed on the telephone's LCD.

1. In standby mode, press **Menu**.
2. Press [▲] or [▼] to select "Basic Settings", and then press **OK**.
3. Press [▲] or [▼] to select "Display Option", and then press **OK**.
4. Press [▲] or [▼] to select "Standby Display", and then press **OK**.
5. Press [▲] or [▼] to select the desired item, and then press **OK**.

Selecting the Display Language

You can select the language displayed on your LCD.

1. In standby mode, press **Menu**.
2. Press [▲] or [▼] to select "Basic Settings", and then press **OK**.
3. Press [▲] or [▼] to select "Display Option", and then press **OK**.
4. Press [▲] or [▼] to select "Language", and then press **OK**.
5. Press [▲] or [▼] to select a language, and then press **OK**.

4.2 Setting the Password

The telephone password is not set by default. You must register a password (4 digits) before use. You cannot use the following features without setting a password:

- Phonebook lock (See "3.6.5 Locking/Unlocking the Local Phonebook".)

Note

- To avoid unauthorized access to this product:
 - Set a password that is random and cannot be easily guessed.
 - Change the password regularly.
- Make a note of the password so that you will not forget it.

To set

1. In standby mode, press **Menu**.
2. Press [**▲**] or [**▼**] to select "Basic Settings", and then press **OK**.
3. Press [**▲**] or [**▼**] to select "Other Option", and then press **OK**.
4. Press [**▲**] or [**▼**] to select "Change Password", and then press **OK**.
5. Enter a new password (4 digits [0–9]).
6. Verify the password by entering it again as in step 5.

4.3 Editing Soft Keys

Reverting to the default settings

1. In standby mode, press **Menu**.
2. Press [▲] or [▼] to select "Basic Settings", and then press **OK**.
3. Press [▲] or [▼] to select "Key Option", and then press **OK**.
4. Press [▲] or [▼] to select "Soft Key Edit", and then press **OK**.
5. Press [▲] or [▼] to select a desired soft key, and then press **OK**.
6. Press [▲] or [▼] to select "Standby"/"Talking", and then press **OK**.
7. Press [▲] or [▼] to select "Default", and then press **OK**.

Assigning Function Keys

1. In standby mode, press **Menu**.
2. Press [▲] or [▼] to select "Basic Settings", and then press **OK**.
3. Press [▲] or [▼] to select "Key Option", and then press **OK**.
4. Press [▲] or [▼] to select "Soft Key Edit", and then press **OK**.
5. Press [▲] or [▼] to select a desired soft key, and then press **OK**.
6. Press [▲] or [▼] to select "Standby" or "Talking", and then press **OK**.
7. Press [▲] or [▼] to select "Function Key", and then press **OK**.
8. Press [▲] or [▼] to select the desired item, and then press **OK**.

Assigning Hot Key Dial keys

1. In standby mode, press **Menu**.
2. Press [▲] or [▼] to select "Basic Settings", and then press **OK**.
3. Press [▲] or [▼] to select "Key Option", and then press **OK**.
4. Press [▲] or [▼] to select "Soft Key Edit", and then press **OK**.
5. Press [▲] or [▼] to select a desired soft key, and then press **OK**.
6. Press [▲] or [▼] to select "Standby" or "Talking", and then press **OK**.
7. Press [▲] or [▼] to select "Hot Key Dial", and then press **OK**.
8. Press [▲] or [▼] to select the desired item, and then press **OK**.

4.4 Using Hot Keys

By assigning phone numbers to dial keys, you can make a call by pressing and holding a dial key. (See "Hot Key Dialing".)

Assigning Hot Keys from Phonebook

You can assign a phone number stored in the Local Phonebook to a key to be used as a Hot Key.

1. In standby mode, press and hold a dial key (0–9) for more than 1 second.
2. Press **Menu**.
3. Press [**▲**] or [**▼**] to select "Copy from P.book", and then press **OK**.
4. Enter the name or the first character(s) of the desired name, and then press **OK**.
5. Press [**▲**] or [**▼**] to the desired item, and then press **OK**.
6. Press [**▲**] or [**▼**] to select a number, and then press **OK**.
7. "Save" is displayed, and then press **OK**.

Note

- For details about searching for an item in the phonebook, see "3.6.4 Searching for an Item in the Local Phonebook".

Editing Hot Keys

1. In standby mode, press and hold a dial key (0–9) for more than 1 second.
2. Press **Menu**.
3. Press [**▲**] or [**▼**] to select "Edit", and then press **OK**.
4. Edit the Hot Key Name, if necessary, and then press **OK**.
5. Edit the Hot Key Number, if necessary, and then press **OK**.
6. "Save" is displayed, and then press **OK**.

Deleting a Hot Key

1. In standby mode, press and hold the dialing key assigned as a Hot Key for more than 1 second.¹
2. Press **Menu**.
3. Press [**▲**] or [**▼**] to select "Delete", and then press **OK**.²
4. Press [**▲**] or [**▼**] to select "Yes", and then press **OK**.

¹ While the Hot Key's information is displayed, you can press [**▲**] or [**▼**] to select another Hot Key number.

² To delete all items, select "Delete All" instead of "Delete".

Selecting the Type of Hot Key Dialing

You can select one of 2 types of Hot Key Dialing for each assigned Hot Key.

1. In standby mode, press and hold a dial key (0–9) for more than 1 second.
2. Press **Menu**.
3. Press [**▲**] or [**▼**] to select "Automatic Call", and then press **OK**.

4.4 Using Hot Keys

4. Select "Manual" or "Auto", and then press **OK**.

Option	Description
Manual	Press and hold the dialing key (0–9) assigned as a Hot Key for more than 1 second, and then go off-hook.
Auto	Pressing and holding an assigned Hot Key for the set number of seconds will dial that Hot Key's assigned number immediately.

Note

- To select the number of seconds before the call is automatically made, see "Hot Key Time" in "Key Option".

4.5 Function Keys (Program Keys and DSS Keys^{*1})

^{*1} KX-HDV230 only

4.5.1 Changing the Function Keys

1. In standby mode, press **Menu**.
2. Press [▲] or [▼] to select "Basic Settings", and then press **OK**.
3. Press [▲] or [▼] to select "Key Option", and then press **OK**.
4. Press [▲] or [▼] to select "Program Key", and then press **OK**.^{*1}
5. Press [▲] or [▼] to select the key to change, and then press **OK**.
6. Press [▲] or [▼] to select the new item to assign, and then press **OK**.^{*2}

^{*1} KX-HDV230 only:

To assign functions to the DSS keys on a KX-HDV20, select "DSS Key". You can also assign a function by pressing the desired DSS Key for 3 or more seconds.

^{*2} To clear the current setting, select "None".

Note

- You can also assign a function by pressing the desired function key for 3 or more seconds (KX-HDV230 only).

4.5.2 The Types of Function Keys

Each of the function keys can be assigned one of the following functions.

Note

- In addition to the Line function, other functions can be assigned to individual lines. However, only lines that have been set up in advance can be selected (KX-HDV230 only).
- If your phone is connected to a Panasonic KX-HTS series PBX, the method for changing these keys and the functions that can be assigned are different. For details, see the documentation for the KX-HTS series PBX.

1. One Touch Dial

Used to dial a previously set phone number with one touch.

2. BLF (Busy Lamp Field)

Used to transfer calls to the extension assigned to the key while receiving an incoming call or during a conversation. The indicator of a BLF key also shows the current status of the extension assigned to the key.

Status		Meaning
Color	Light pattern	
Red	Off	Available
	On	Unavailable
	Quick Flashing	Ringing

4.5.2 The Types of Function Keys

Note

- More than 48 BLF keys can be programmed, but status indication is available only up to 48 keys (KX-HDV230 only).

3. Line

Used to seize a line in order to make or receive a call. The color of each key's indicator shows the status of the line.

Status		Meaning
Color	Light pattern	
Blue	On	In Use <ul style="list-style-type: none"> • You are on a call.
	Slow Flashing	Line On Hold <ul style="list-style-type: none"> • A call is on hold.
	Quick Flashing	Incoming Call or Recall <ul style="list-style-type: none"> • A call (including Hold Recall) is being received. Name or number of caller <ul style="list-style-type: none"> • A call to a shared line is being received.
Red	On	In Use <ul style="list-style-type: none"> • A shared line is in use or a call is on private hold at another unit.
	Slow Flashing	Line On Hold <ul style="list-style-type: none"> • A shared line is on hold at another unit.
Off	—	Free <ul style="list-style-type: none"> • The line is idle.

4. ACD ^{*1}

Login: Used to log in/log out of an Automatic Call Distribution Group.

Wrap Up: Used to change the phone's status from "Unavailable" → "Wrap Up" → "Available".

The color of each key's LED indicates the status of the key.

Status		Meaning	
Color	Light pattern	Login	Wrap Up
Red	Off	Login	Available
	On	Logout	Unavailable
	Slow Flashing	—	Wrap Up

5. Line Status ^{*2}

Used to confirm the status of each line. This allows the function key to work as a Line key such as seizing a line in order to make or receive a call.

See "3.7 Checking the Line Status".

6. Call Forward

Used to forward incoming calls to the extension assigned to the key.

7. Phonebook ^{*2 *3}

Used to open the phonebook.

8. Call History ^{*2 *3}

Used to open the Incoming / Outgoing Call Log.

9. Simultaneous Ring ^{*1 *2}

Enables parallel ringing. Up to 10 locations can be specified to ring simultaneously when you receive a call.

Status		Meaning
Color	Light pattern	
Blue	On	Simultaneous Ring feature: On
	Off	Simultaneous Ring feature: Off

10. Hoteling/Hospitality ^{*1 *2}

Used to log in/log out of the Call Center Hoteling Event.

11. Transfer ^{*2}

Used to transfer a call to the extension assigned to the key by confirmation transfer or automatic transfer during a conversation.

12. Blind Transfer ^{*1 *2}

Used to transfer a call to the extension assigned to the key by blind transfer during a conversation.

13. Conference ^{*2}

Used to add the extension assigned to the key to a multiple-party conversation (conference).

14. Directed Call Pickup ^{*1 *2}

Used to answer an incoming call arriving at the specified telephone number.

15. Call Park ^{*1 *2}

Used to park a call (Call Parking).

16. Park Retrieve ^{*1 *2}

Used to retrieve a parked call.

17. Presence ^{*2}

Used to confirm the current status of the extension assigned to the key.

When the extension is "Available", you can call the registered telephone number by pressing the key.

Status		Meaning
Color	Light pattern	
Blue	On	Available
Red	On	Busy
	Slow Flashing	Away
Off	—	Offline

(My Phone) ^{*2}

Used to configure the current status of My Phone. The status can be changed by pressing the key.

Status		Meaning
Color	Light pattern	
Blue	On	Available
Red	On	Busy
	Slow Flashing	Away
Off	—	Offline / Invisible

4.5.2 The Types of Function Keys

18. Group Pickup ^{*1}

Used to answer a group call.

*1 This item can be used only when the feature is enabled. Contact your administrator for further information.

*2 KX-HDV230 only

*3 This item can be selected when the list is registered on the telephone. Contact your administrator for further information.

4.6 Using the Anonymous Call Features

Making an Anonymous Call

Before making a call, specify the following:

Note

- Availability depends on your phone system.
- A password may be required for these settings. We recommend setting with your administrator. Contact your administrator for further information.

1. Press **Menu**.
2. Press [▲] or [▼] to select "Basic Settings", and then press **OK**.
3. Press [▲] or [▼] to select "Call Settings", and then press **OK**.
4. Press [▲] or [▼] to select "Anonymous Call", and then press **OK**.
5. Press [▲] or [▼] to select a line, and then press **OK**.
6. Press [▲] or [▼] to select "On", and then press **OK**.

Blocking Anonymous Calls

This feature allows the unit to reject calls when the unit receives a call without phone number. The default setting is "Off".

Note

- A password may be required for these settings. We recommend setting with your administrator. Contact your administrator for further information.

1. Press **Menu**.
2. Press [▲] or [▼] to select "Basic Settings", and then press **OK**.
3. Press [▲] or [▼] to select "Call Settings", and then press **OK**.
4. Press [▲] or [▼] to select "Block Anonymous", and then press **OK**.
5. Press [▲] or [▼] to select a desired line, and then press **OK**.
6. Press [▲] or [▼] to select "On", and then press **OK**.

4.7 Barring Incoming Calls (Caller ID^{*1} service users only)

This feature allows the unit to reject calls from specified phone numbers that you do not want to answer such as junk calls.

When a call is received, the unit does not ring while the caller is being identified.

If the phone number matches an entry in the call barred list, the unit rejects the call.

^{*1} If an outside call that contains Caller ID information (a caller's name and telephone number) is received, this information will be logged in the incoming call log and displayed on the LCD.

If a call from a number matching a number entered in the phonebook is received, the name registered in the phonebook for that number will be displayed along with the number.

If caller information is sent by the phone system and there is also information stored in the phonebook for the same number, the information stored in the phonebook will be displayed.

Note

- A password may be required for these settings. We recommend setting with your administrator. Contact your administrator for further information.

Storing unwanted callers

You can store up to 30 phone numbers in the call barred list by using the caller list or by entering the numbers directly.

1. Press **Menu**.
2. Press [**▲**] or [**▼**] to select "Basic Settings", and then press **OK**.
3. Press [**▲**] or [**▼**] to select "Call Settings", and then press **OK**.
4. Press [**▲**] or [**▼**] to select "Block Caller ID", and then press **OK**.
5. Press [**▲**] or [**▼**] to select a blank line, and then press **Menu**.
6. Press [**▲**] or [**▼**] to select "Edit", and then press **OK**.
7. Enter the phone number (max. 32 digits), and then press **OK**.
8. Press **Save**.

Note

- You can also register a phone number by pressing **Menu** and selecting "Block Caller ID" when a caller who you want to block is selected on the incoming call log list and continuing the procedure from step 7.

Editing the phone numbers to reject

1. Press **Menu**.
2. Press [**▲**] or [**▼**] to select "Basic Settings", and then press **OK**.
3. Press [**▲**] or [**▼**] to select "Call Settings", and then press **OK**.
4. Press [**▲**] or [**▼**] to select "Block Caller ID", and then press **OK**.
5. Press [**▲**] or [**▼**] to select a desired phone number, and then press **Menu**.
6. Press [**▲**] or [**▼**] to select "Edit", and then press **OK**.
7. Enter the phone number, and then press **OK**.

8. Press **Save**.

Deleting the phone numbers to reject

1. Press **Menu**.
2. Press [▲] or [▼] to select "Basic Settings", and then press **OK**.
3. Press [▲] or [▼] to select "Call Settings", and then press **OK**.
4. Press [▲] or [▼] to select "Block Caller ID", and then press **OK**.
5. Press [▲] or [▼] to select a desired phone number, and then press **Menu**.
6. Press [▲] or [▼] to select "Delete Number"^{*1}, and then press **OK**.
7. Press [▲] or [▼] to select "Yes", and then press **OK**.

^{*1} To delete all items, select "Delete All No." instead of "Delete Number".

4.8 Setting ECO Mode

Enabling this mode reduces the amount of electricity consumed by the unit.

Note

- When ECO mode is enabled, the "Link Speed" setting changes as follows:
 - Link Speed: "10M/Full"^{*1}
 - PC port cannot be used
 - When the ECO mode setting is changed, the unit will restart.
 - When ECO mode is enabled, **ECO** is displayed while the unit is in standby mode.
- ^{*1} The port of the switching hub to which the unit is connected must be 10 Mbps (Fixed) / full duplex.

To set

1. In standby mode, press **Menu**.
2. Press [**▲**] or [**▼**] to select "ECO Mode"^{*1}, and then press **OK**.
3. Press [**▲**] or [**▼**] to select "On"^{*2}, and then press **OK**.

^{*1} The administrator password may be required for this setting. Contact your administrator for further information. For available characters, see "5.2 Character Table for Administrator Password".

^{*2} To disable ECO mode, select "Off" (default).

4.9 Changing the Basic Setting

To select the main item

1. In standby mode, press **Menu**.
2. Press [▲] or [▼] to select "Basic Settings", and then press **OK**.
3. Press [▲] or [▼] to select the main item, and then press **OK**.

Main item	Sub Item
Incoming Option	Ringer Volume, Ringer Type
Talk Option	Speaker Volume, Handset Volume, Headset Volume
Answer Option	Auto Ans Device, Auto Ans Delay
Key Option	Program Key, Soft Key Edit, Soft Key Name, Hot Key Time
Display Option	Language, Backlight, LCD Contrast, Standby Display, Category Name, Date Format, Time Format, Notification
Key Tone	—
Call Settings	Block Anonymous, Anonymous Call, Block Caller ID, Anywhere, Remote Office, SimultaneousRing, System Lock
Other Option	Change Password, Embedded Web

4.9.1 Basic Settings Menu Layout

Incoming Option

Sub Item	Description	Setting		Default
Ringer Volume	Adjusts the ringer volume.	Off, Level 1–Level 8		Level 5
Ringer Type	Selects the ringtone for each type of call. ^{*1}	For KX-HDV130: Line 1, Line 2	Ringtone 1–19, 25–32	Ringtone 1 ^{*2}
		For KX-HDV230: Line 1–Line 6		
		Private Ring (Category 1– Category 9)		

^{*1} The preset melodies in this product are used with permission of © 2010 Copyrights Vision Inc.

^{*2} The default ringtone is different depending on the line number. For example, the default for line 3 is ringtone 3.

4.9.1 Basic Settings Menu Layout

Talk Option

Sub Item	Description	Setting	Default
Speaker Volume	Adjusts the speaker volume.	Level 1–Level 8	Level 5
Handset Volume	Adjusts the handset volume.	Level 1–Level 8	Level 5
Headset Volume	Adjusts the headset speaker volume.	Level 1–Level 8	Level 5
Equalizer ^{*1}	Selects the type of receiver quality.	Normal / Treble ^{*2}	Normal

*1 KX-HDV230 only

*2 Emphasizes the high-frequency.

Answer Option

Sub Item	Description	Setting	Default
Auto Ans Device	Selects the types of devices that can be answered by Auto Answer.	Speaker Phone / Headset	Speaker Phone
Auto Ans Delay	Selects the number of seconds before a call is automatically answered when Auto Answer is turned on.	0s–20s	6s

Key Option

Sub Item	Description	Setting	Default
Program Key For KX-HDV130 : • Program Key 1–2 For KX-HDV230 : • Program Key 1–24 • DSS Key 1–200	Assigns a function to each program key or DSS key. See "4.5 Function Keys (Program Keys and DSS Keys ¹)".	None One Touch Dial BLF Line ACD (Login / Wrap Up) Line Status ¹ Call Forward Phonebook ¹ Call History ¹ Simultaneous Ring ¹ Hoteling/Hospitality ¹ Transfer ¹ Blind Transfer ¹ Conference ¹ Directed Call Pickup ¹ Call Park ¹ Park Retrieve ¹ Presence ¹ Group Pickup	None
Soft Key Edit • Softkey A • Softkey B • Softkey C	Edits the soft keys in the following situations. • Standby • Talking	Default	Not stored
		Function Key FWD/DND ³ Flash/Recall ⁴ Incoming Log Outgoing Log Phonebook Call Park ^{2 4} Pause ² Paging ^{2 3}	
		Hot Key Dial ³	
Soft Key Name • Softkey A • Softkey B • Softkey C	Edits the names of the soft keys in the following situations. • Standby • Talking	Max. 5 characters	Not stored
Hot Key Time	Selects the number of seconds before a call is automatically made when a Hot Key assigned to "Auto" is pressed and held.	1s–20s	2s

¹ KX-HDV230 only

² Displayed only when configured on the telephone.

³ Displayed only when "Standby" is selected.

⁴ Displayed only when "Talking" is selected.

Display Option

Sub Item	Description	Setting		Default
Language	Selects the display language. Up to 10 languages can be downloaded from the server or Web as necessary. Contact your administrator for further information.	Suffix: NE / X / SX	Auto / English / Deutsch / Español / FRANÇAIS / Italiano / Svenska / Nederlands / Português / Čeština	Auto
		Suffix: (none) / C	Auto / English / Español / FRANÇAIS	Auto
		Suffix: RU	Auto / English / РУССКИЙ / Українська	Auto
Backlight	Turns the LCD backlight on or off. If "Auto" or "On" is selected, set the brightness of the backlight from Level 1–3 (KX-HDV130) / Level 1–6 (KX-HDV230).	Auto / On / Off		Auto
LCD Contrast	Adjusts the contrast of the backlight of the LCD.	For KX-HDV130 : Level 1–Level 6		Level 3
		For KX-HDV230: Main LCD / Sub LCD / DSS LCD	Level 1–Level 6	
Standby Display	Selects what is shown on the display while in standby mode.	Phone Number / Phone No&Name / Name / Off		Phone Number
Category Name	Edits the names of the categories.	Max. 13 characters x Category (1–9)		Not stored
Date Format	Selects the format for the date shown on the display in standby mode.	Suffix: NE / X / SX / RU	DD-MM-YYYY / MM-DD-YYYY	DD-MM-YYYY
		Suffix: (none) / C	DD-MM-YYYY / MM-DD-YYYY	MM-DD-YYYY

Sub Item	Description	Setting		Default
Time Format	Selects the format for the time shown on the display in standby mode.	Suffix: NE / X / SX / RU	12H / 24H	24H
		Suffix: (none) / C	12H / 24H	12H
Notification	Selects the notification method (Message, LED, or Alarm) for missed calls and voice messages. Message: Displays a message on the screen LED: Indicator lights Alarm: An alarm sounds	Missed Call		All settings: On
		Message	On / Off	
		LED	On / Off	
		Voice MSG		
		Message	On / Off	
		LED	On / Off	
	Alarm	On / Off		

Key Tone

Sub Item	Description	Setting	Default
Key Tone	Turns the key tone on or off.	On / Off	On

Call Settings

Sub Item	Description	Setting		Default
Block Anonymous	Specifies whether or not to block incoming anonymous calls.	For KX-HDV130: Line 1–Line 2 For KX-HDV230: Line 1–Line 6	On / Off	Off
Anonymous Call ^{*1}	Specifies whether or not to make outgoing anonymous calls.	For KX-HDV130: Line 1–Line 2 For KX-HDV230: Line 1–Line 6	On / Off	Off
Block Caller ID	Edits/deletes the phone numbers to reject incoming calls.	See "4.7 Barring Incoming Calls (Caller ID ^{*1} service users only)".		Not stored
Anywhere ^{*3}	Specifies/edits the Xsi's Anywhere settings.	For KX-HDV130: Line 1–Line 2 For KX-HDV230: Line 1–Line 6	When registering: Name Phone Number ^{*2} When editing: Status (On / Off) Name Phone Number ^{*2} Alt. Number ^{*2}	Not stored

4.9.1 Basic Settings Menu Layout

Sub Item	Description	Setting		Default
Remote Office ^{*3}	Specifies the Xsi's Remote Office setting.	For KX-HDV130: Line 1–Line 2 For KX-HDV230: Line 1–Line 6	On / Off ^{*2} Phone Number ^{*2}	Off
SimultaneousRing ^{*3}	Specifies the Xsi's Simultaneous Ring setting.	For KX-HDV130: Line 1–Line 2 For KX-HDV230: Line 1–Line 6	On / Off ^{*2} Phone Number ^{*2}	Off
System Lock	Selects whether to lock the Call Settings menu.	On ^{*4} / Off		Off

^{*1} This item is displayed only when the feature is enabled. Contact your administrator for further information.

^{*2} In a phone number that exceeds 32 digits, the exceeding digits will not be displayed.

^{*3} If the Xsi's service is available, you can select this item. Contact your administrator for further information.

^{*4} Password is required (4 digits).

Other Option

Sub Item	Description	Setting	Default
Change Password ^{*1}	Changes the telephone password (4 digits) used for unlocking the Phonebook.	<ol style="list-style-type: none"> 1. Enter Old Password.^{*2} 2. Enter New Password. 3. Verify New Password. 	Not registered
Embedded Web ^{*3}	Selects whether the web function and the logging function are available or not.	On / Off	Off

- ^{*1}
- To avoid unauthorized access to this product:
 - Set a password that is random and cannot be easily guessed.
 - Change the password regularly.

- Make a note of the password so that you will not forget it.

- For details about setting the password, see "4.2 Setting the Password".

^{*2} If a password has not already been set, this step is skipped.

^{*3} The administrator password may be required for this setting. Contact your administrator for further information. For available characters, see "5.2 Character Table for Administrator Password".

4.10 Changing the System Settings

Note

- The feature depends on your phone system. Contact your administrator for further information.

To select the main item

- In standby mode, press **Menu**.
- Press [**▲**] or [**▼**] to select "System Settings", and then press **OK**.
- Press [**▲**] or [**▼**] to select the main item, and then press **OK**.

Main item	Sub Item
Status	Line Status, Firmware Version, IP Mode, IPv4 Settings, IPv6 Settings, MAC Address, LLDP, CDP, VLAN
Network Settings	IP Mode Select, IPv4 Settings, IPv6 Settings, LLDP, CDP, VLAN, Link Speed, Embedded Web, Network Test
System Settings	Set Time & Date, Authentication, Access Code, Xsi Setting, UC Setting, Restart, DSS Restart (KX-HDV230 only)

4.10.1 System Settings Menu Layout

Status

Sub Item	Description	Status
Line Status For KX-HDV130: Line 1–Line 2 For KX-HDV230: Line 1–Line 6	Displays the line status.	Registered ¹ / Registering ¹ (NULL)
Firmware Version	Displays the firmware version of the telephone.	—
IP Mode	Displays the IP network mode.	IPv4 / IPv6 / IPv4&IPv6
IPv4 Settings	Displays information about IPv4 settings.	IP Address ² Subnet Mask ² Default Gateway ² DNS ²
IPv6 Settings	Displays information about IPv6 settings.	IP Address ³ Prefix ⁴ Default Gateway ³ DNS ³
MAC Address	Displays the MAC address of the telephone.	—
LLDP	Displays the LLDP status.	On / Off
CDP	Displays the CDP status.	On / Off

4.10.1 System Settings Menu Layout

Sub Item	Description	Status
VLAN	Displays the VLAN ID and priority.	—

- *1 If you select this item and press **OK**, the phone number of the selected line is displayed.
- *2 If this item is not set, “...” is displayed. If the telephone is not connected to the network, “...” is displayed.
- *3 If this item is not set, “0::0” is displayed. If the telephone is not connected to the network, “::” is displayed.
- *4 If this item is not set, “0” is displayed. If the telephone is not connected to the network, a blank is displayed.

Network Settings

The administrator password may be required for Network Settings. Contact your administrator for further information. For available characters, see "5.2 Character Table for Administrator Password".

Sub Item	Description	Setting		Default
IP Mode Select	Changes the network settings of the telephone. Current settings are displayed as a highlight.	IPv4 / IPv6 / IPv4&IPv6		IPv4
IPv4 Settings	Specifies the IPv4 settings.	DHCP	Auto / Manual (DNS 1 / DNS 2)	DHCP – Auto
		Static	IP Address Subnet Mask Default Gateway DNS 1 DNS 2	
IPv6 Settings	Specifies the IPv6 settings.	DHCP	Auto / Manual (DNS 1 / DNS 2)	DHCP – Auto
		RA	DNS 1 DNS 2	
		Static	IP Address Prefix Default Gateway DNS 1 DNS 2	
LLDP	Specifies the LLDP settings.	PC Port	VLAN ID	0
			Priority	0
		On / Off		On
CDP	Specifies the CDP settings.	On / Off		Off
VLAN	Specifies the VLAN settings.	Enable VLAN	Yes / No	No
		IP Phone	VLAN ID	2
			Priority	7
		PC	VLAN ID	1
Priority	0			
Link Speed ¹	Specifies the Ethernet PHY mode settings.	IP Phone	Auto / 100M/Full / 100M/Half / 10M/Full / 10M/Half	Auto
		PC	Auto / 100M/Full / 100M/Half / 10M/Full / 10M/Half	Auto

4.10.1 System Settings Menu Layout

Sub Item	Description	Setting	Default
Embedded Web	Selects whether the web function and the logging function are available or not.	On / Off	Off
Network Test	Specifies an IP address to ping.	IP Address (IPv4)	Not stored

*1 If a connection with Auto Negotiation fails, the connection will be made at either 10 Mbps/half duplex or 100 Mbps/half duplex.

System Settings

Sub Item	Description	Setting		Default
Set Time & Date ^{*1}	Specifies the time and date of the telephone.	—		—
Authentication ^{*2}	Specifies the ID and password for HTTP authentication.	ID ^{*3} Password ^{*3}		Not stored
Access Code ^{*4}	Specifies the access code to access the redirect server.	Max. 16 characters		Not stored
Xsi Setting ^{*5}	Specifies the ID and password for the Xsi service.	For KX-HDV130: Line 1–Line 2 For KX-HDV230: Line 1–Line 6	ID ^{*3} Password ^{*3}	Not stored
UC Setting ^{*5}	Specifies the ID and password for the Broadsoft UC service (IM&P).	ID ^{*3} Password ^{*3}		Not stored
Restart	Restart the unit.	Yes / No		No
DSS Restart ^{*6}	Restart any connected DSS units.	Yes / No		No

*1 Availability depends on your phone system. When the power supply is cut off due to a power outage or other reasons or after the unit is restarted, a reconfiguration will be necessary as the current setting values are deleted. Therefore, it is recommended to use the NTP server. Contact your administrator for further information.

*2 The administrator password may be required for this setting. Contact your administrator for further information. For available characters, see "5.2 Character Table for Administrator Password".

*3 Max. 128 characters

*4 This setting may not be displayed depending on the settings of this unit. Contact your administrator for further information.

*5 This item is displayed only when the feature is enabled. Contact your administrator for further information.

*6 KX-HDV230 only

4.11 Web User Interface Programming

The product provides a Web-based interface for configuring various settings and features, including some that are not programmable directly.

The following list contains some useful features that are programmable through the Web user interface. Contact your administrator for further information.

- Language Settings (IP Phone / Web)
- User Password (for access to Web user interface)
- Default Line for Outgoing
- Call Rejection Phone Numbers
- Call Features
 - Enable Anonymous Call
 - Enable Block Anonymous Call
 - Enable Do Not Disturb
 - Enable Call Forwarding Always
 - Forwarding Number (Always)
 - Enable Call Forwarding Busy
 - Forwarding Number (Busy)
 - Enable Call Forwarding No Answer
 - Forwarding Number (No Answer)
 - Ring Counts (No Answer)
- Hotline Number
- Flexible Key Setting^{*1}
- Program Key^{*2}
- Phonebook Import and Export
- DSS Console^{*1}

^{*1} KX-HDV230 only

^{*2} KX-HDV130 only

Note

- Each time you want to access the Web user interface, you must enable Web programming (Embedded Web).

4.12 Updating the Software

Your phone system dealer may offer new features and improve its software version from time to time. Contact your administrator for further information.

Section 5

Appendix

This section contains specifications, troubleshooting, error messages and wall mounting templates.

5.1 Character Mode Table

Character entry modes

The six character entry modes let you enter a variety of characters. The following character modes are available:

- Latin **ABC**
- Numeric **0-9**
- Greek **ΑΒΓ**
- Extended 1 **ÀÁÂ / +ÃÄ**
- Extended 2 **ŠšŠ**
- Cyrillic **АБВ**

Suffix: [none] / C

Keys	ABC (Latin)	0-9 (Numeric)	+ÀÁ (Extended 1)
[1]	Space # & ' () * , - . / 1	1	Space # & ' () * , - . / 1
[2]	A B C 2	2	A À Á Â Ã Ä Å Æ B C Ç 2
	a b c 2		a à á â ã ä å æ b c ç 2
[3]	D E F 3	3	D Đ E È É Ê Ë Ì 3
	d e f 3		d ð e è é ê ë ì 3
[4]	G H I 4	4	G Ğ H Î Ï Ñ Ò Ó 4
	g h i 4		g ğ h î ï ñ ò ó 4
[5]	J K L 5	5	J K L 5
	j k l 5		j k l 5
[6]	M N O 6	6	M N Ñ O Ò Ó Ô Õ Ö Ø 6
	m n o 6		m n ñ o ò ó ô õ ö ø 6
[7]	P Q R S 7	7	P Q R S Ş ß 7
	p q r s 7		p q r s ş ß 7
[8]	T U V 8	8	T U Û Ü Ú Û Ü V 8
	t u v 8		t u ù ú û ü v 8
[9]	W X Y Z 9	9	W Ŵ X Y Ŷ Z 9
	w x y z 9		w ŵ x y ŷ z 9
[0]	Space ! ? " : ; + = < > 0	0	Space ! ? " : ; + = < > 0
[#]	\$ % & @ € £	#	\$ % & @ € £

- For each key, the upper row shows the characters entered in uppercase mode, and the lower row shows the characters entered in lowercase mode.
- Press [X] before or after entering a character to change between uppercase and lowercase.
- Pressing a key repeatedly will cycle through the characters associated with that key. For example, to enter the letter "C" in Latin Mode, press [2] 3 times.
- Characters that are entered using the [#] key (for example, "\$") cannot be entered when searching the phonebook.
- The illustrations of the keys in the table may differ in appearance from the actual keys on the telephone.

5.1 Character Mode Table

Suffix: NE / X / SX

Keys	ABC (Latin)	0-9 (Numeric)	ΑΒΓ (Greek)	ÀÁÂ (Extended 1)	Ššš (Extended 2)
[1]	Space # & ' () * , - . / 1	1	Space # & ' () * , - . / 1		
[2]	A B C 2	2	Α Β Γ 2	À Á Â Ã Ä Å Æ B C Ç 2	Š Œ Š Š Œ B C C Č 2
	a b c 2		α β γ 2	à á â ã ä å æ b c ç 2	š œ š š œ b c c č 2
[3]	D E F 3	3	Δ Ε Ζ 3	Đ Ę È É Ê Ë Ě F 3	D Ď E É Ě Ě F 3
	d e f 3		δ ε ζ 3	d ě è é ê ë ě f 3	d ě e é ě ě f 3
[4]	G H I 4	4	Η Θ Ι 4	G Ğ H I İ Í Î Ï Ī 4	G H I Í 4
	g h i 4		η θ ι 4	ğ ğ h i i í î ï i ĩ 4	g h i í 4
[5]	J K L 5	5	Κ Λ Μ 5	J K L 5	J K L Ł Ł Ľ 5
	j k l 5		κ λ μ 5	j k l 5	j k l ł ł ľ 5
[6]	M N O 6	6	Ν Ξ Ο 6	M N Ñ O Ò Ó Ô Õ Ö Ø Œ 6	M N Ń Ņ O Ó Ő Ő Ö 6
	m n o 6		ν ξ ο 6	m ñ ñ o ò ó ô õ ö ø œ 6	m n ń ņ o ó ő ő ö 6
[7]	P Q R S 7	7	Π Ρ Σ 7	P Q R S Ş ß 7	P Q R Ř Ŕ Š Š Š 7
	p q r s 7		π ρ σ 7	p q r s ş ß 7	p q r ř ŕ š š š 7
[8]	T U V 8	8	Τ Υ Φ 8	T U Û Ú Ü Ü Ů V 8	T Ţ Ť U Ú Ů Ů Ů V 8
	t u v 8		τ υ φ 8	t u ù ú ü ü ů v 8	t ť ŧ u ú ů ů ů v 8
[9]	W X Y Z 9	9	Χ Ψ Ω γ 9	W Ŵ X Y Ŷ Z 9	W X Y Ÿ Ý Z Ž Ž Ž 9
	w x y z 9		χ ψ ω γ 9	w ŵ x y ŷ z 9	w x y ÿ ý z ž ž ž 9
[0]	Space ! ? " : ; + = < > 0	0	Space ! ? " : ; + = < > 0		
[#]	\$ % & @ € £	#	\$ % & @ € £		

- For each key, the upper row shows the characters entered in uppercase mode, and the lower row shows the characters entered in lowercase mode.
- Press [*] before or after entering a character to change between uppercase and lowercase.
- Pressing a key repeatedly will cycle through the characters associated with that key. For example, to enter the letter "C" in Latin Mode, press [2] 3 times.
- Characters that are entered using the [#] key (for example, "\$") cannot be entered when searching the phonebook.
- The illustrations of the keys in the table may differ in appearance from the actual keys on the telephone.

Suffix: RU

Keys	АБВ (Cyrillic)	0-9 (Numeric)	ABC (Latin)	ÀÁÂ (Extended 1)	Ššš (Extended 2)
1	А Б В Space G + - / = < > 1	1	Space # & ' () * , - . / 1		
	а б в Space G + - / = < > 1				
2	Г Д Е Ё 2	2	ABC 2	À Á Â Ã Ä Å Æ B C Ç 2	Á Â Ã Ä Å B C Č Ć 2
	г д е ё 2		abc 2	a à á â ã ä å æ b c ç 2	á á ä ä å b c č ĉ 2
3	Ж З И Й 3	3	DEF 3	D Đ E È É Ê Ë Ě F 3	D Ď E Ě Ě Ě F 3
	ж з и й 3		def 3	d ð e è é ê ë ě f 3	d ě e ě ě ě f 3
4	К Л М 4	4	GHI 4	G Ğ HI Ì Í Î Ï Ĭ 4	G H Í 4
	к л м 4		ghi 4	g ģ h i ì í î ï ĭ 4	g h í 4
5	Н О П 5	5	JKL 5	JKL 5	JKL Ł Ł Ľ 5
	н о п 5		jkl 5	jkl 5	jkl ł ł ľ 5
6	Р С Т 6	6	MNO 6	M N Ñ O Ò Ó Ô Õ Ö Ø Œ 6	M N Ń Ń O Ó Ö Ö 6
	р с т 6		mno 6	m n ñ o ò ó ô õ ö ø œ 6	m n ń ń o ó ö ö 6
7	У Ф Х 7	7	PQRS 7	P Q R S Ş ß 7	P Q R Ŕ Ŕ S Š Š 7
	у ф х 7		pqrs 7	p q r s ş ß 7	p q r ŕ ŕ s š š 7
8	Ц Ч Ш 8	8	TUV 8	T U Û Ú Ū Ŭ Ů V 8	T Ť Ť U Ú Ů Ů V 8
	ц ч ш 8		tuv 8	t u ù ú ŭ ů v 8	t ť ť u ú ů ů v 8
9	Щ Ъ Ы Ь Space ! ? " 9	9	WXYZ 9	W Ŵ X Y Ŷ Z 9	W X Y Ý Ý Z Ž Ž Ž 9
	щ ъ ы ь Space ! ? " 9		wxyz 9	w ŵ x y ŷ z 9	w x y ý ý z ž ž ž 9
0	Э Ю Я Space . , ' ; () 0	0	Space ! ? " ; ; + = < > 0		
	э ю я Space . , ' ; () 0				
#	\$ % & @ € £ Ğ € İ İ Ÿ #	#	\$ % & @ € £		
	\$ % & @ € £ Ğ € ı İ Ÿ #				

- For each key, the upper row shows the characters entered in uppercase mode, and the lower row shows the characters entered in lowercase mode.
- Press **✖** before or after entering a character to change between uppercase and lowercase.

5.1 Character Mode Table

- Pressing a key repeatedly will cycle through the characters associated with that key. For example, to enter the letter "C" in Latin Mode, press **2** 3 times.
- Pressing a key repeatedly will cycle through the characters associated with that key. For example, to enter the letter "E" in Cyrillic Mode, press **2** 3 times.
- Characters that are entered using the **#** key (for example, "\$") cannot be entered when searching the phonebook.
- The illustrations of the keys in the table may differ in appearance from the actual keys on the telephone.

5.2 Character Table for Administrator Password

Keys	ABC (Latin)	0-9 (Numeric)
1	# & ' () ✖ , - . / ~ 1	1
2	A B C 2	2
	a b c 2	
3	D E F 3	3
	d e f 3	
4	G H I 4	4
	g h i 4	
5	J K L 5	5
	j k l 5	
6	M N O 6	6
	m n o 6	
7	P Q R S 7	7
	p q r s 7	
8	T U V 8	8
	t u v 8	
9	W X Y Z 9	9
	w x y z 9	
0	Space ! ? " ' : ; + = < > 0	0
#	\$ % & @ [\] ^ _ ` { }	#

- For each key, the upper row shows the characters entered in uppercase mode, and the lower row shows the characters entered in lowercase mode.
- Press **✖** before or after entering a character to change between uppercase and lowercase.
- Pressing a key repeatedly will cycle through the characters associated with that key. For example, to enter the letter "C" in Latin Mode, press **2** 3 times.

5.3 Specifications

KX-HDV130

Item		Specifications	
Power Supply		AC adaptor / PoE (IEEE 802.3af)	
Power Consumption	PoE	Standby	<ul style="list-style-type: none"> • approx. 2.2 W (ECO mode off) • approx. 1.9 W (ECO mode on)
		Talking	<ul style="list-style-type: none"> • approx. 2.3 W (ECO mode off) • approx. 2.0 W (ECO mode on)
	AC Adaptor	Standby	<ul style="list-style-type: none"> • approx. 2.0 W (ECO mode off) • approx. 1.3 W (ECO mode on)
		Talking	<ul style="list-style-type: none"> • approx. 2.1 W (ECO mode off) • approx. 1.4 W (ECO mode on)
Maximum Power Consumption		Approx. 2.8 W	
Operating Environment		0 °C (32 °F) to 40 °C (104 °F)	
Ethernet Port		LAN: 1 (RJ45), PC: 1 (RJ45)	
Ethernet Interface		10Base-T / 100Base-TX (Auto / 100MB-FULL / 100MB-HALF / 10MB-FULL / 10MB-HALF) Auto MDI / MDIX	
Wideband Codec		G.722	
Narrowband Codec		G.711a-law / G.711μ-law / G.729a	
Multiple Line		2	
LCD Display		Monochrome graphical	
LCD Size		132 × 64 pixels, 4 lines	
LCD Backlight		3 levels	
VoIP Connection Method		SIP	
Speaker		1	
Microphone		1	
Headset Jack		1 (RJ9)	
Dimensions (Width × Depth × Height; stand attached)	"High" position	167 mm × 168 mm × 184 mm (6.57 in × 6.61 in × 7.24 in)	
	"Low" position	167 mm × 187 mm × 151 mm (6.57 in × 7.36 in × 5.94 in)	
Weight (with handset, handset cord and stand)		691 g (1.52 lb)	

KX-HDV230

Item			Specifications
Power Supply			AC adaptor / PoE (IEEE 802.3af)
Power Consumption	PoE	Standby	<ul style="list-style-type: none"> • approx. 3.1 W (ECO mode off) • approx. 2.9 W (ECO mode on)
		Talking	<ul style="list-style-type: none"> • approx. 3.2 W (ECO mode off) • approx. 3.0 W (ECO mode on)
	AC Adaptor	Standby	<ul style="list-style-type: none"> • approx. 2.8 W (ECO mode off) • approx. 2.1 W (ECO mode on)
		Talking	<ul style="list-style-type: none"> • approx. 2.9 W (ECO mode off) • approx. 2.2 W (ECO mode on)
Maximum Power Consumption			Approx. 4.2 W
Operating Environment			0 °C (32 °F) to 40 °C (104 °F)
Ethernet Port			LAN: 1 (RJ45), PC: 1 (RJ45)
Ethernet Interface			10Base-T / 100Base-TX / 1000Base-T (Auto / 100MB-FULL / 100MB-HALF / 10MB-FULL / 10MB-HALF) Auto MDI / MDIX
Wideband Codec			G.722
Narrowband Codec			G.711a-law / G.711 μ -law / G.729a
Multiple Line			6
LCD Display			Monochrome graphical
LCD Size			132 × 64 pixels, 4 lines (main LCD) 160 × 384 pixels, 12 lines (self-labeling LCD)
LCD Backlight			6 levels
VoIP Connection Method			SIP
Speaker			1
Microphone			1
Headset Jack			1 (RJ9)
EHS Jack			1 (\varnothing 3.5 mm [1/8 in], for EHS only)
Dimensions (Width × Depth × Height; stand attached)	"High" position	252 mm × 179 mm × 188 mm (9.9 in × 7.1 in × 7.4 in)	
	"Low" position	252 mm × 187 mm × 154 mm (9.9 in × 7.4 in × 6.1 in)	
Weight (with handset, handset cord and stand)			1030 g (2.28 lb)

5.3 Specifications

KX-HDV20

Item		Specifications
Power Supply ^{*1}		Power is supplied from the KX-HDV230.
Power Consumption		Stand-by: approx. 0.5 W
Maximum Power Consumption		Approx. 1.5 W
Operating Environment		0 °C (32 °F) to 40 °C (104 °F)
LCD Display		Monochrome graphical
LCD Size		160 × 384 pixels, 12 lines
LCD Backlight		6 levels
Dimensions (Width × Depth × Height; stand attached)	"High" position	110 mm × 175 mm × 178 mm (4.3 in × 6.9 in × 7.0 in)
	"Middle" position	110 mm × 176 mm × 154 mm (4.3 in × 6.9 in × 6.1 in)
	"Low" position	110 mm × 176 mm × 121 mm (4.3 in × 6.9 in × 4.8 in)
Weight (with stand)		430 g (0.95 lb)

*1 The KX-HDV20 can be used only when the KX-HDV230 is receiving power from the optional AC adaptor.

5.4 Troubleshooting



General Use

Issue	Possible Cause	Solution
The display is blank.	The unit is not receiving power.	The unit is not designed to function when there is a power failure. Make sure that the device supplying PoE is receiving power and that the Ethernet cable is properly connected. (If you are using a PoE hub, the number of devices that you can connect simultaneously is limited by the amount of power supplied by the hub.) If an AC adaptor is connected, confirm that the AC adaptor is connected and receiving power.
The unit is not performing properly.	Cables or cords are not connected properly.	Check all connections.
	Your connection settings are incorrect.	<ul style="list-style-type: none"> Consult your administrator to confirm that your settings are correct. If the problem persists, consult your dealer.
	An error has occurred.	Restart the unit.
I cannot hear a dial tone.	—	Confirm that the LAN cable is properly connected.
I cannot cancel the phonebook lock.	The password you entered was incorrect.	Enter the correct password.
I forgot my password.	—	Consult your administrator or dealer.
The date and time are not correct.	—	Adjust the date and time of the unit.
The Message/Ringer lamp is lit.	You received a voice message while you were on the phone or away from your desk.	Check the voice message.
The KX-HDV20 will not turn on (KX-HDV230 only).	The KX-HDV230 is receiving power via Power-over-Ethernet (PoE).	Connect the KX-HDV230 to an AC power outlet using the optional AC adaptor.

Making and Receiving Calls

Issue	Possible Cause	Solution
I cannot make calls.	The phone number was entered incorrectly.	<ul style="list-style-type: none"> • Confirm that you have entered the phone number of the other party correctly. • Consult your administrator or dealer.
	The unit is downloading a firmware update.	You cannot make calls while the unit is downloading updates. Wait for the update to finish, and then try making a call.
	The phonebook list is being imported or exported.	<ul style="list-style-type: none"> • Wait a few minutes for the operation to complete. • Confirm with your administrator or dealer.
I cannot make long distance calls.	Your telephone service does not allow you to make long distance calls.	Make sure that you have subscribed to your telephone company's long distance service.
The unit does not ring when a call is received.	The ringer is turned off.	Press the [+] volume key while a call is being received, or change the ringer volume setting.
While talking to an outside party, the line is disconnected.	Your phone system/service may impose a time limit on outside calls.	Consult your dealer to extend the time limit, if necessary.

Sound Quality

Issue	Possible Cause	Solution
The other party cannot hear my voice.	The unit is muted.	Press  /  / MUTE/AUTO ANS to turn off the mute feature.
	If you are using the speakerphone, objects may be obstructing the microphone.	Do not obstruct the unit's microphone during calls. Keep your hands, as well as common objects such as folders, cups, and coffee pots away from the unit during calls.
Sound cuts out; I can hear myself through the speaker.	You are too far away from the microphone.	Try speaking closer to the microphone.
	The environment is not suited to speakerphone calls.	<ul style="list-style-type: none"> Do not use the unit within 2 m (6 ft 7 in) of projectors, air conditioning devices, fans, or other audible or electrical noise emitting devices. If using the unit in a room with windows, close the curtains or blinds to prevent echoes. Use the unit in a quiet environment.
	The unit was moved during a call.	Do not move the unit while on a call.
	Objects are obstructing the microphone.	Do not obstruct the unit during calls. Keep your hands, as well as common objects such as folders, cups, and coffee pots away from the unit during calls.
	The other party is using a half-duplex phone.	If the other party is using a half-duplex phone, sound may cut out occasionally during calls. For best performance, the other party should use a full-duplex phone.

Phonebook List

Issue	Possible Cause	Solution
I cannot add or edit entries to the phonebook list.	The phonebook list is full.	Delete any unnecessary entries. The maximum number of entries in the phonebook list is 500.

5.5 Error Messages

During operation, error messages might appear on the unit.
The following table lists these messages and possible causes and solutions.

Error Message	Possible Cause	Solution
Error:001 Check LAN cable.	The LAN cable is not connected.	Check all connections.
Error:002 IP Address Collision	The unit's network settings are incorrect.	Consult your system administrator or dealer.
Error:002 IP Address		
Error:003 Not Registered	Failed to register to SIP server.	Consult your system administrator or dealer.
Memory Full	The Phonebook is full and cannot store the new item.	Remove unnecessary data in the Phonebook and try again.
No Entries	When trying to view the Phonebook: No items have been stored. When trying to view the Incoming or Outgoing Call Log: No logs have been stored.	Store a new item in your local phonebook.
Need Repair	Device fault.	Contact your phone system dealer/ service provider.
Phonebook Error	The memory became full during a phonebook download.	<ul style="list-style-type: none"> Remove unnecessary data in the phonebook, or consult your administrator regarding the number of items being downloaded. This message disappears if you access the phonebook.

5.6 Revision History

Software File Version 06.000 or later

New Contents

- Network Settings—Network Test

Software File Version 07.000 or later

New Contents

- Talk Option—Equalizer

5.7 Wall mounting template

1. Drive the screws into the wall as indicated.
2. Hook the unit onto the screw heads.

Note

- Make sure to set the print size to correspond with the size of this page. If the dimensions of the paper output still deviate slightly from the measurements indicated here, use the measurements indicated here.

5.7.1 KX-HDV130

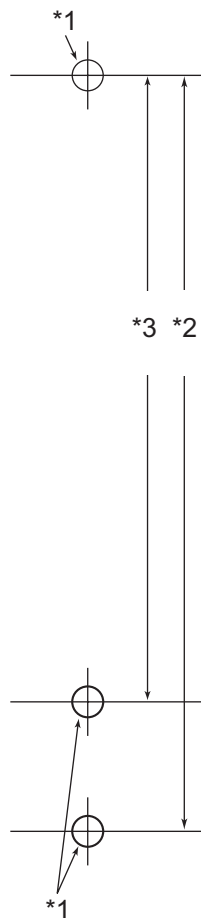

- *1 One screw here
- *2 100 mm (3 15/16 in)
- *3 83 mm (3 1/4 in)

5.7.2 KX-HDV230, optionally with 1 attached KX-HDV20

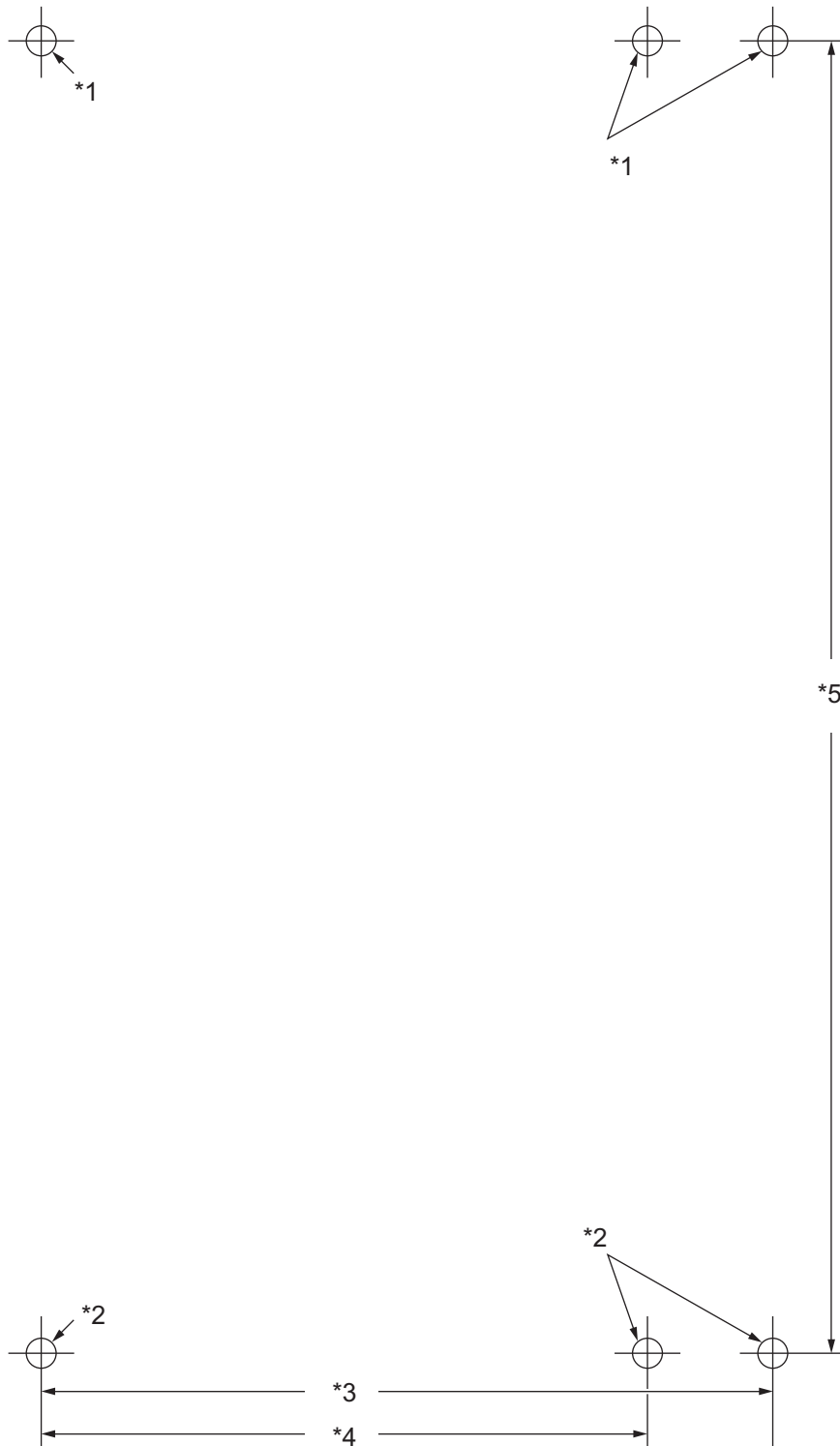

- *1 One screw here (for KX-HDV20)
- *2 One screw here (for KX-HDV230)
- *3 100 mm (3 15/16 in)
- *4 83 mm (3 1/4 in)
- *5 179.3 mm (7 1/16 in)

5.7.3 For mounting 2 or more KX-HDV20 units (KX-HDV230 only)

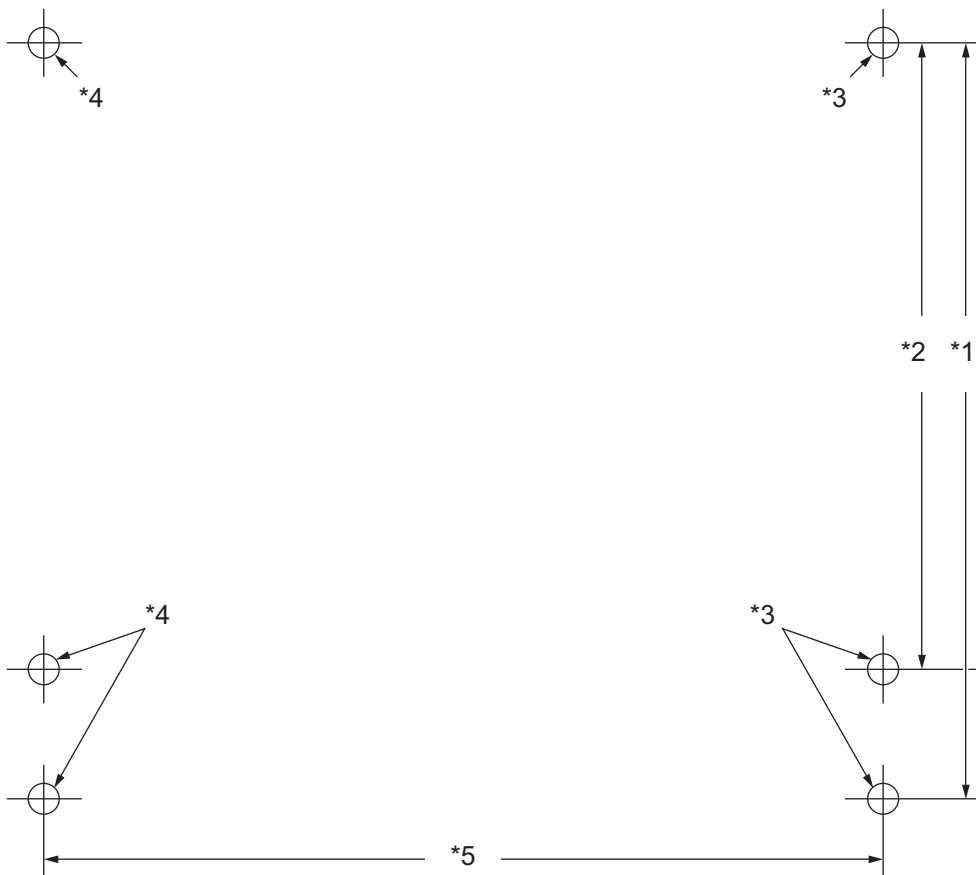

- *1 100 mm (3 15/16 in)
- *2 83 mm (3 1/4 in)
- *3 One screw here (for KX-HDV20 to mount)
- *4 One screw here (previously mounted KX-HDV20)
- *5 111 mm (4 3/8 in)

Note

Panasonic Corporation

1006, Oaza Kadoma, Kadoma-shi, Osaka 571-8501, Japan

<https://panasonic.net/cns/pcc/support/sipphone/>

Panasonic Corporation of North America

Two Riverfront Plaza, Newark, New Jersey 07102-5490

<https://panasonic.net/cns/pcc/support/sipphone/>

Panasonic Canada Inc.

5770 Ambler Drive, Mississauga, Ontario, L4W 2T3

<http://www.panasonic.com/ca/>